



Fusionsolar

Utility Smart String ESS Solution

SOLAR.HUAWEI.COM





HUAWEI

About Huawei

Huawei is a leading global provider of information and communications technology (ICT) infrastructure and smart devices. With integrated solutions across four key domains – telecom networks, IT, smart devices, and cloud services – we are committed to bringing digital to every person, home and organization for a fully connected, intelligent world. Huawei's end-to-end portfolio of products, solutions and services are both competitive and secure. Through open collaboration with ecosystem partners, we create lasting value for our customers, working to empower people, enrich home life, and inspire innovation in organizations of all shapes and sizes. At Huawei, innovation focuses on customer needs. We invest heavily in basic research, concentrating on technological breakthroughs that drive the world forward.



Employees

207,000+



R&D Personnel

55.4%



Countries

170+



Best Global Brands

86



R&D Investment

4



Most Innovative Companies

8

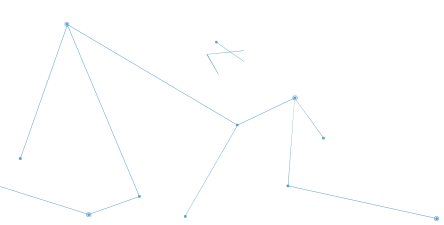

FusionSolar Smart String ESS Solution

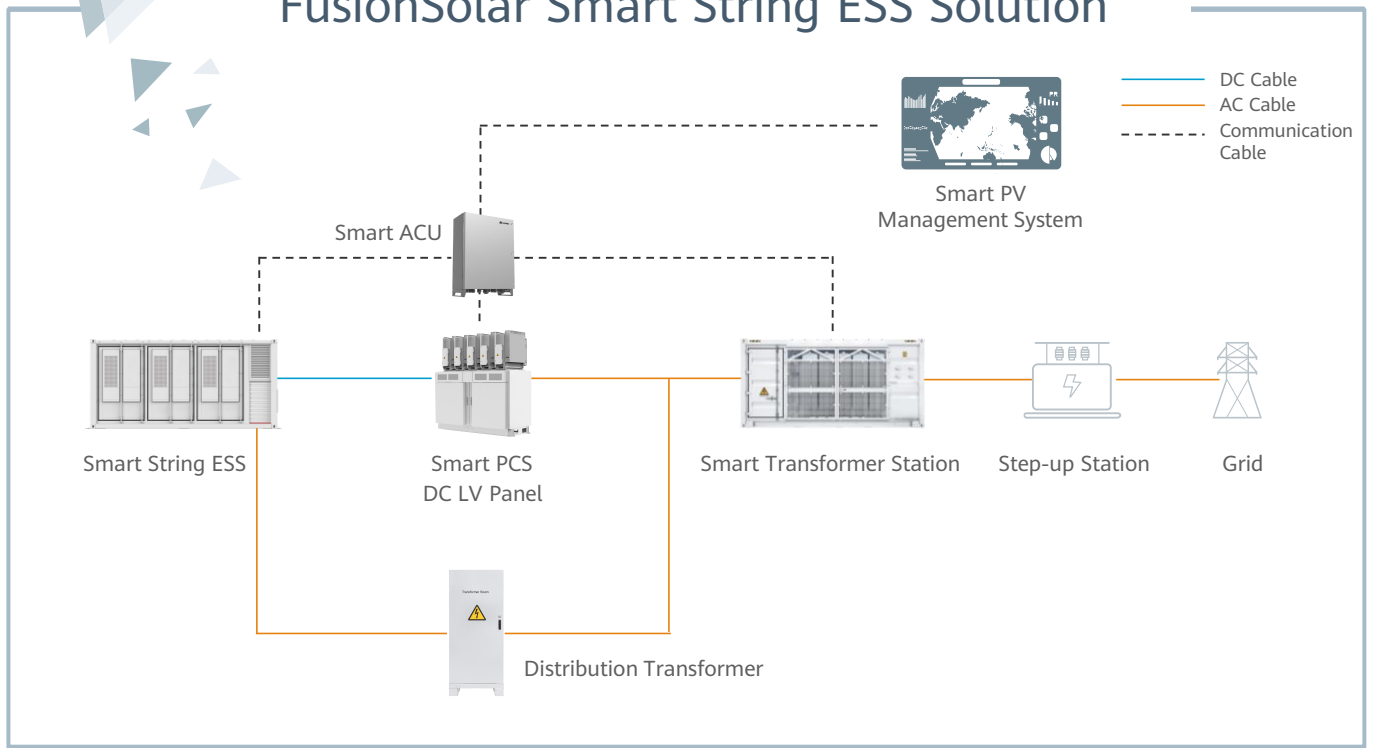

More Energy

Pack-level optimization
Rack-level optimization

Optimal Investment

Support battery augmentation
Reducing Initial configuration

Simple O&M

Auto SOC calibration
No experts site visit

Safe & Reliable

Modular design
Multi-level safety design



LUNA2000-2.0MWH Series Smart String ESS



More Energy



Optimal Investment



Simple O&M



Safe & Reliable

Battery Container			
Model	LUNA2000-2.0MWH-1H1	LUNA2000-2.0MWH-2H1	LUNA2000-2.0MWH-4H1
DC Rated Voltage	1,250 V	1,250 V	1,250 V
DC Max. Voltage	1,500 V	1,500 V	1,500 V
Nominal Energy Capacity	2,032 kWh	2,032 kWh	2,032 kWh
Charge & Discharge Rate	≤ 1 C	≤ 0.5 C	≤ 0.25 C
Rated Power	2,032 kW	1,016 kW	508 kW
Container Configuration (W x H x D)	6,058 x 2,896 x 2,438 mm	6,058 x 2,896 x 2,438 mm	6,058 x 2,896 x 2,438 mm
Container Weight	≤ 30 t	≤ 30 t	≤ 30 t
Operation Temperature Range	-30°C ~ 55°C	-30°C ~ 55°C	-30° C ~ 55° C
Storage Temperature Range	-40°C ~ 60°C	-40°C ~ 60°C	-40° C ~ 60° C
Relative Humidity	0 ~ 100% (Non-condensing)	0 ~ 100% (Non-condensing)	0 ~ 100% (Non-condensing)
Max. Operating Altitude	4,000 m	4,000 m	4,000 m
Cooling Method	Smart Air Cooling	Smart Air Cooling	Smart Air Cooling
Configuration of HVAC	6 HVACs ¹	4 HVACs ¹	2 HVACs 1
Fire Suppression System	Novec 1230™ + Water Sprinkler	Novec 1230™ + Water Sprinkler	Novec 1230™ + Water Sprinkler
Communication Interface	Ethernet / SFP	Ethernet / SFP	Ethernet / SFP
Communication Protocol	Modbus TCP / IEC 104	Modbus TCP / IEC 104	Modbus TCP / IEC 104
Protection Degree	IP55	IP55	IP55
Anti-corrosion Degree	C5-Medium	C5-Medium	C5-Medium
Black Start	Optional	Optional	Optional

Standards Compliance

RoHS, IEC62477-1, IEC62040-1, IEC61000-6-2, EN55011, UL9540A, IEC62619, UN3536, etc.

¹ - The quantity of HVACs depends on C rate and application scenario

LUNA2000-1.0MWH-1H1

Smart String ESS



More Energy



Optimal Investment



Simple O&M



Safe & Reliable

Battery Container

Model	LUNA2000-1.0MWH-1H1
DC Rated Voltage	1,250 V
DC Max. Voltage	1,500 V
Nominal Energy Capacity	1,016 kWh
Rated Power	1,016 kW
Container Configuration (W x H x D)	6,058 x 2,896 x 2,438 mm
Container Weight	≤ 20 t
Operation Temperature Range	-30°C ~ 55°C
Storage Temperature Range	-40°C ~ 60°C
Relative Humidity	0 ~ 100% (Non-condensing)
Max. Operating Altitude	4,000 m
Cooling Method	Smart Air Cooling
Configuration of HVAC	3 HVACs
Fire Suppression System	Novec 1230™ + Water Sprinkler
Communication Interface	Ethernet / SFP
Communication Protocol	Modbus TCP / IEC 104
Protection Degree	IP55
Anti-corrosion Degree	C5-Medium
Black Start	Yes

Standards Compliance

RoHS, IEC62477-1, IEC62040-1, IEC61000-6-2, EN55011, UL9540A, , IEC62619, UN3536, etc.

Battery Pack & Smart Rack Controller

Smart String ESS



Battery Pack

General

BESS Model	LUNA2000-2.0MWH-1H0	LUNA2000-2.0MWH-1H1/2H1 LUNA2000-1.0MWH-1H1
Cell Material	LFP	LFP
Pack Configuration	16S 1P	18S 1P
Rated Voltage	51.2 V	57.6 V
Nominal Capacity	320 Ah / 16.38 kWh	280 Ah / 16.13 kWh
Weight	≤ 140 kg	≤ 140 kg
Dimensions (W x H x D)	442 x 307 x 660 mm	442 x 307 x 660 mm



Smart Rack Controller

Battery Side

Rated Voltage	1,209.6 V
Operating Voltage Range	40 V ~ 1,400 V
Rated Power Voltage Range	1,075 V ~ 1,320 V
Min. Start Voltage	350 V

Bus Side

Max. DC Voltage	1,500 V
Rated Voltage	1,250 V
Rated Current	275.2 A
Rated Power	344,000 W

General

Dimensions (W x H x D)	600 x 270 x 820 mm
Weight	≤ 90 kg
Cooling Method	Smart Air Cooling
Protection Degree	IP66

LUNA2000-200KTL-H1 Smart PCS



Max. Efficiency 99%



Modular Design



IP66 Protection



Surge Arresters for
DC & AC



Ethernet
Communication



Smart Grid
Algorithm

Efficiency Curve

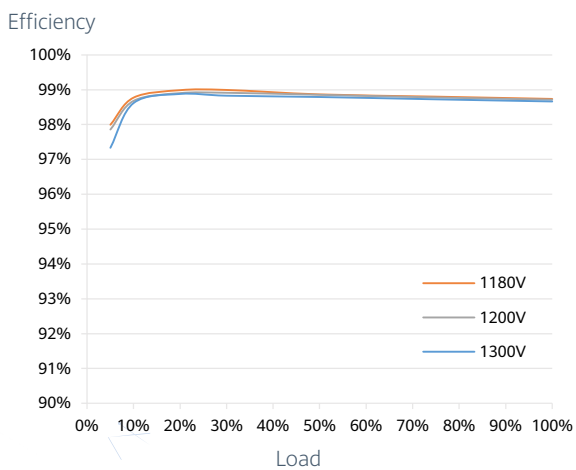

Circuit Diagram

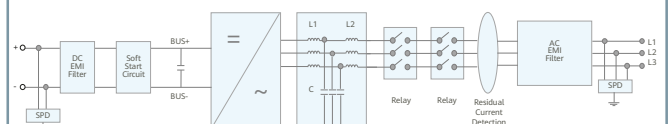

LUNA2000-200KTL Series

LUNA2000-200KTL-H1 Technical Specifications

Model	LUNA2000-200KTL-H1	
Efficiency		
Max. Efficiency	99.0%	
DC Side		
Rated DC Voltage	1,180 V	
Max. DC Voltage	1,500 V	
Operating DC Voltage Range	1,180 V ~ 1,500 V	
Max. DC Current	207.6 A	
Max. Number of Inputs	1	
AC Side		
Rated AC Active Power	200,000 W @40°C	
Rated AC Voltage	800 V	
Rated AC Grid Frequency	50 Hz / 60 Hz	
Max. AC Current	173.2 A	
Adjustable Power Factor Range	-1 ... +1	
Max. Total Harmonic Distortion	THD _i < 1% (Rated)	
Black Start	-	Yes
Protection		
AC Overcurrent Protection	Yes	
DC Reverse-polarity Protection	Yes	
Insulation Resistance Detection	Yes	
Residual Current Protection	Yes	
DC Surge Protection ¹	Type II	
AC Surge Protection ¹	Type II	
Communication		
Display	LED Indicators, WLAN + APP	
USB	Yes	
Ethernet	Yes	
General		
Dimensions (W x H x D)	875 x 820 x 365 mm	
Weight	< 99 kg	
Operating Temperature Range	-25°C ~ 60°C	
Cooling Method	Smart Air Cooling	
Max. Operating Altitude without Derating	4,000 m	
Relative Humidity	0 ~ 100% (Non-condensing)	
DC Connector	OT / DT Terminal	
AC Connector	OT / DT Terminal	
Protection Degree	IP66	
Anti-corrosion Degree	C5-Medium	
Topology	Transformerless	
Standards Compliance		

RoHS, IEC 62477-1, IEC 61000-6-2, IEC 61683, VDE 4120, EN 50549, etc.

¹ - Compatible Type II protection class according to IEC / EN 61643-11

JUPITER-9000K-H0 / STS-6000K/3000K-H1 Smart Transformer Station

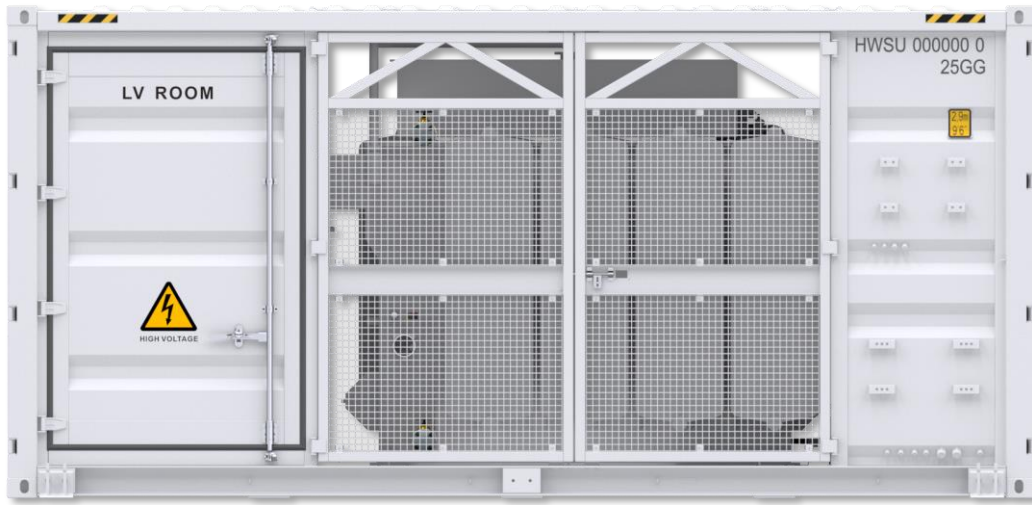

Simple

Prefabricated and Pre-tested, No Internal Cabling Needed Onsite
Compact 20' HC Container Design for Easy Transportation



Efficient

High Efficiency Transformer for Higher Yields
Lower Self-consumption for Higher Yields



Smart

Real-time Detection of Transformer, LV Panel and RMU
High Precision Sensor of LV Electricity Parameters
Remote Control of ACB and MV Circuit Breaker



Reliable

Robust Design against Harsh Environments
Optimal Cooling Design for High Availability and Easy O&M
Comprehensive Tests from Components, Device to Solution

Schematic Diagram

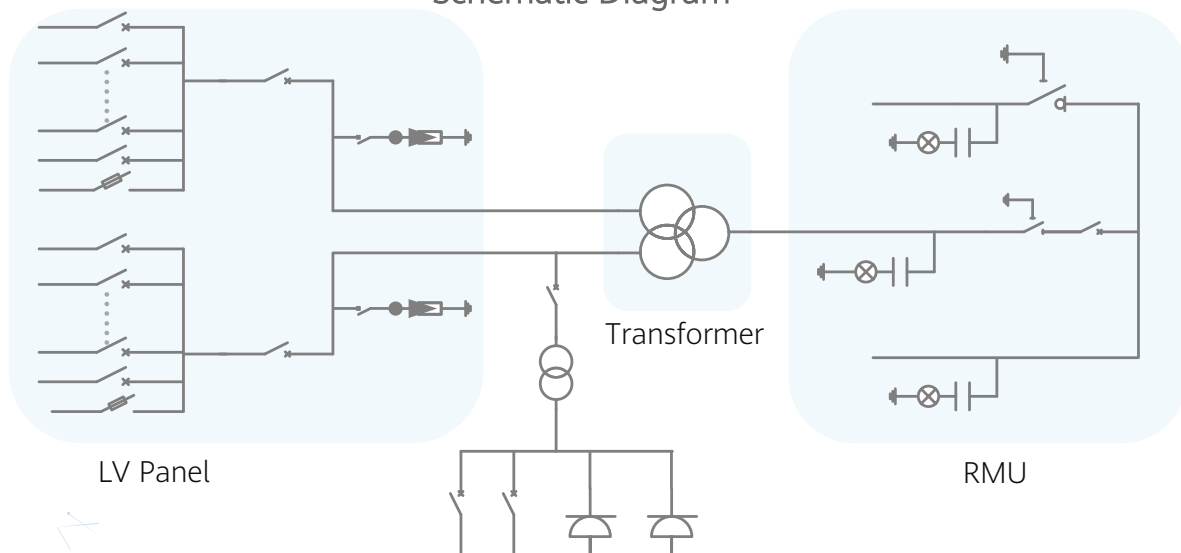

Technical Specifications

Technical Specifications	JUPITER-9000K-H0	STS-6000K-H1	STS-3000K-H1
Input			
Available Inverters	LUNA2000-200KTL		
Max. LV AC Inputs	44	34	17
AC Power	9,000 kVA @40°C ¹	6,800 kVA @40°C ¹	3,400 kVA @40°C ¹
Rated Input Voltage	800 V		
LV Panel Segregation	Form 2b		
LV Main Switches	ACB (4,000 A, 2 x 1 pcs)	ACB (2,900 A, 2 x 1 pcs)	ACB (2,900 A, 1 pcs)
LV Main Switches for LUNA2000-200KTL	MCCB (250 A, 2 x 22 pcs)	MCCB (250 A, 2 x 17 pcs)	MCCB (250 A, 17 pcs)
Output			
Rated Output Voltage	10~35 kV ²		
Frequency	50 Hz / 60 Hz		
Transformer Type	Oil-immersed, Conservator Type		
Transformer Cooling Type	ONAN		
Transformer Tappings	± 2 x 2.5%		
Transformer Oil Type	Mineral Oil (PCB Free)		
Transformer Vector Group	Dy11-y11		Dy11
Transformer Min. Peak Efficiency Index	Tier 1 or Tier 2 In Accordance with EN 50588-1		
RMU Type	SF ₆ Gas Insulated		
RMU Transformer Protection Unit	MV Vacuum Circuit Breaker Unit		
RMU Cable Incoming / Outgoing Unit	Direct Cable Unit or Cable Load Break Switch Unit		
Auxiliary Transformer	Dry Type Transformer, 5 kVA, Single-phase, li0	Dry Type Transformer, 5 kVA, Three-phase, Dyn11	
Output Voltage of Auxiliary Transformer	230 / 127 Vac	400 / 230 Vac or 220 / 127 Vac	
Protection			
Transformer Detection & Protection	Oil Level, Oil Temperature, Oil Pressure and Buchholz		
Protection Degree of MV & LV Room	IP 54		
Internal Arcing Fault of STS	IAC A 20 kA 1s		
MV Relay Protection	50/51, 50N/51N		
LV Overvoltage Protection	Type I+II		
Anti-rodent Protection	C5-Medium		
Features			
2 kVA UPS	Optional ³		
MV Surge Arrester for MV VCB	Optional ³		
General			
Dimensions (W x H x D)	6,058 x 2,896 x 2,438 mm (20' HC ISO Container)		
Weight	< 28 t	< 22 t	< 15 t
Operating Temperature Range	-25°C ~ 60°C ⁴		
Relative Humidity	0% ~ 95% (Non-condensing)		
Max. Operating Altitude	1,000 m ⁵		
MV-LV AC Connections	Prewired and Pretested, No Internal Cabling Onsite		
LV & MV Room Cooling	Smart Cooling without Air-across for Higher Availability		
Communication	Modbus TCP, Preconfigured with SmartACU2000D	Modbus RTU, Preconfigured with SmartACU2000D	
Standard Compliance			
IEC 62271-202, EN 50588-1, IEC 60076, IEC 62271-200, IEC 61439-1, etc.			

1 - More detailed AC power of STS, please refer to the de-rating curve.
 2 - Rated output voltage from 10 kV to 35 kV, more available upon request
 3 - Extra expense needed for optional features which standard product doesn't contain, more options upon request.
 4 -When ambient temperature ≥55°C, awning shall be equipped for STS on site by customer.
 5- For higher operating altitude, pls consult with Huawei.

DCBOX-9/5-H0

DC LV Panel



Electrical	
Max. Input Voltage	1,500 V
Nominal Input Voltage	1,200 V
Max. Branch Current for Battery Rack Side	321 A
Max. Branch Current for PCS Side	193 A
Number of DC Circuit Breaker	14
Max. Input Number of Battery Rack	9
Max. Input Number of PCS	5
Max. Convergence Capacity	5 x 193 A
Protection	
DC Overcurrent Protection	Yes
Environment	
Operating Temperature Range	-30°C ~ 60°C
Relative Humidity	0 ~ 100% (Non-condensing)
Max. Operating Altitude	4,000 m
General	
Cable Entries	Top in for PCS & Bottom in for Battery Rack
Dimensions (W x H x D)	2,040 x 1,415 x 975 mm
Weight (Without Smart PCS)	≤ 750 kg
DC Connector / AC Connector	OT Terminal
Protection Degree	IP55
Installation Options	Grounding

DTS-200K-D0

Distribution Transformer



Electrical	
AC Power	210 kVA@ 400 Vac / 4 kVA@ 110 Vac
Rated Input Voltage	800 Vac
Max. Input Current at Nominal Voltage	151.6 A
Rated Output Voltage	400V (3P) /110V (1P)
Rated Frequency	50 / 60 Hz
Transformer Type	Dry Type
Transformer Cooling Type	AF
Transformer Vectoring Group	Dyn11yn11
Transformer Tappings	± 2 x 2.5%
Transformer Winding	Al
Transformer Insulation Class	H
Transformer Impedance (at 145°C)	4% (±10%) @50Hz / 4.8% (±10%) @60Hz
Transformer No-load Loss	≤ 500 W (+15%)
Transformer Load Loss	≤ 3,044 W (+15%)
Cablings	
Number of outputs	Five MCCBs, Each Connected to Two Outputs
Cabling mode	Routed in And out From the Bottom
Protection	
Protection Degree	IP 55
LV SPD	Type II
Transformer Protection	Transformer Temperature Protection
Environment	
Operating Temperature Range	- 30°C ~ 55°C
Relative Humidity	0% ~ 95% (Non-condensing)
Max. Operating Altitude	4,000 m
General	
Dimensions (W x H x D)	900 x 2,100 x 1,200 mm
Weight	< 1.3 t
Communication Mode	Dry Contacts
Cooling Type	Smart Cooling without Air-across for Higher Availability
Standard Compliance	
IEC 60076, IEC 61439	

SmartACU2000D

Smart Array Controller



With SmartPID2000 Module



Without SmartPID2000 Module



Smart

Support one-click commissioning
Patented anti-PID module



Simple

SmartPID2000 & Smartlogger3000B
pre-installed with multiple interfaces



Reliable

Industrial-level application
and high reliability

Technical Specifications	SmartACU2000D-D-06	SmartACU2000D-D-00	SmartACU2000D-D-01	SmartACU2000D-D-03
Configuration				
SmartLogger	SmartLogger3000B x 1			
SmartModule1000A	Optional			Standard with 1
Ethernet	14	1 or 3 (with a SmartModule1000A) or 6 (with a SmartModule1000A and a five-port switch)		
RS485	COM x 6, 1,200 / 2,400 / 4,800 / 9,600 / 19,200 / 115,200 bps			
Optical Ethernet	SFP x 10, 100 / 1,000 Mbps	SFP x 2, 100 / 1,000 Mbps		
Number of MBUS Module ¹	0	1	1	2
Number of SmartPID2000 Module	0	0	1	2
SmartIMD Function	-		Optional	
Environment				
Operating Temperature Range	-40°C ~ 60°C			
Relative Humidity	4% ~ 100% (Non-condensing)			
Max. Operating Altitude	4,000 m			
Electrical				
AC Input Voltage for Cabinet	100 V ~ 240 V, L / N (L)+ PE			
AC Input Voltage for MBUS	380 V ~ 800 V, 3Ph			
AC Input Voltage for PID	380 V ~ 800 V, 3Ph + FE (Functional Earth)			
AC Input Frequency	50 Hz / 60 Hz			
Power Supply	Standard: 12 V DC, Optional: 24 V DC ²			
Mechanical				
Cable Entries	Bottom in & out			
Maintenance	Front			
Dimensions (W x H x D)	640 x 770 x 315 mm		880 x 770 x 369 mm	
Weight	32 kg	29 kg	49 kg	61 kg
Protection Degree	IP65			
Installation Options	Wall Mounting, Rack Mounting, Pole Mounting			

1 - Compatible with communication mode of PLC (Power Line Communication).

2 - 24 V DC power supply is optional to power devices that require 24 V DC input and output.

SmartLogger3000B

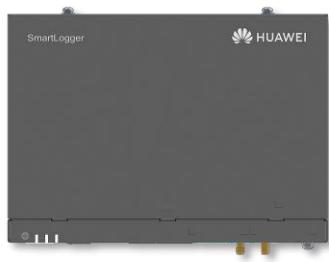

Without SmartModule1000A

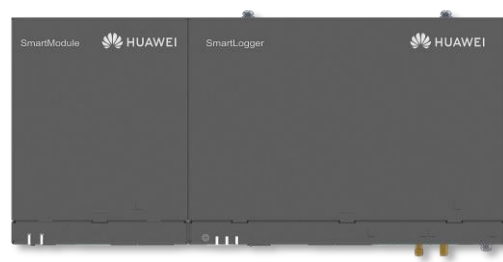

With SmartModule1000A



Smart

Connecting up to 24 ESS and 44 PCS
One-click commissioning



Simple

Deployment wizard allowed, including
parameters configuration, devices connection



Reliable

Safety improvement
by lightning protection module

Technical Specifications	SmartLogger3000B	SmartLogger3000B with SmartModule1000A
Device Management		
Max. Manageable Devices	200	
Max. Manageable Smart PCS / String ESS	44 / 22	
Communication Interface		
WAN	WAN x 1, 10 / 100 / 1,000 Mbps	
LAN	LAN x 1, 10 / 100 / 1,000 Mbps	LAN x 3, 10 / 100 / 1,000 Mbps
Optical Ethernet	SFP x 2, 100 / 1,000 Mbps	
MBUS	MBUS x 1, 115.2 kbps, Compatible with PLC	
RS485	COM x 3, 1,200 / 2,400 / 4,800 / 9,600 / 19,200 / 115,200 bps	COM x 6, 1,200 / 2,400 / 4,800 / 9,600 / 19,200 / 115,200 bps
Digital / Analog Input / Output	DI x 4, DO x 2, AI x 4	DI x 8, DO x 2, AI x 7
PT100 / PT1000	0	2
Active DO	12 V, 100 mA (connection with relay, sensor)	
Communication Protocol		
Ethernet	Modbus-TCP, IEC 60870-5-104	
RS485	Modbus-RTU, IEC 60870-5-103 (standard), DL / T645	
Interaction		
LED	LED Indicator x 3	LED Indicator x 5
WEB	Embedded Web	
USB	USB 2.0 x 1	
APP	Communication by WLAN for commissioning	
Environment		
Operating Temperature Range	-40°C ~ 60°C	
Storage Temperature Range	-40°C ~ 70°C	
Relative Humidity	5% ~ 95% (Non-condensing)	
Max. Operating Altitude	4,000 m	
Electrical		
Power Adapter	AC input: 100 V ~ 240 V, 50 Hz / 60 Hz; DC output: 12 V, 2 A	
DC Power Supply	24 V, 0.8 A	
Power Consumption	Typical 9 W, Max. 15 W	Typical 10 W, Max. 18 W
Mechanical		
Dimensions (W x H x D, without mounting ears)	225 x 160 x 44 mm	350 x 160 x 44 mm
Weight	2 kg	3 kg
Protection Degree	IP20	
Installation Options	Wall Mounting, DIN Rail Mounting, Tabletop Mounting	

1 - One smartlogger supports max. manageable devices for either smart PV controller or Smart string ESS in one power block.

SmartPID2000 Module Inside Smart Array Controller



The SmartPID2000 Module is installed in the SmartACU2000D cabinet and support continuous DC & AC insulation detection with optional Smart IMD.



Smart

Data read and software upgrade through USB or the embedded Web



Safe & Reliable

Inject LV AC voltage to earth
Continuous DC & AC insulation detection with optional Smart IMD

SmartPID2000 Solution Diagram

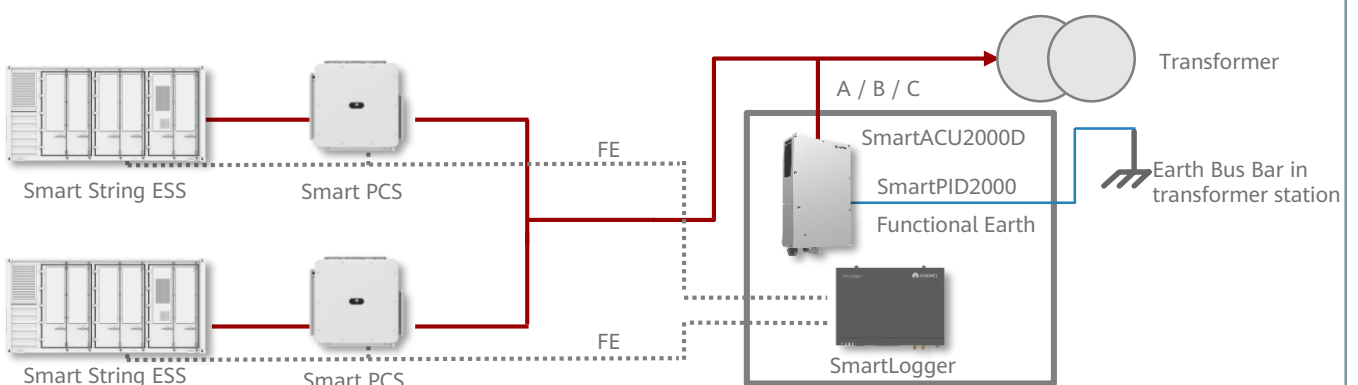

Note:

- 1 - The SmartPID module could ONLY be deployed in utility scenarios where the LV sides of transformer stations are IT system.
- 2 - The SmartPID module must work with FusionSolar SmartLoggers and smart PV controllers / smart PCS.

Network Applications

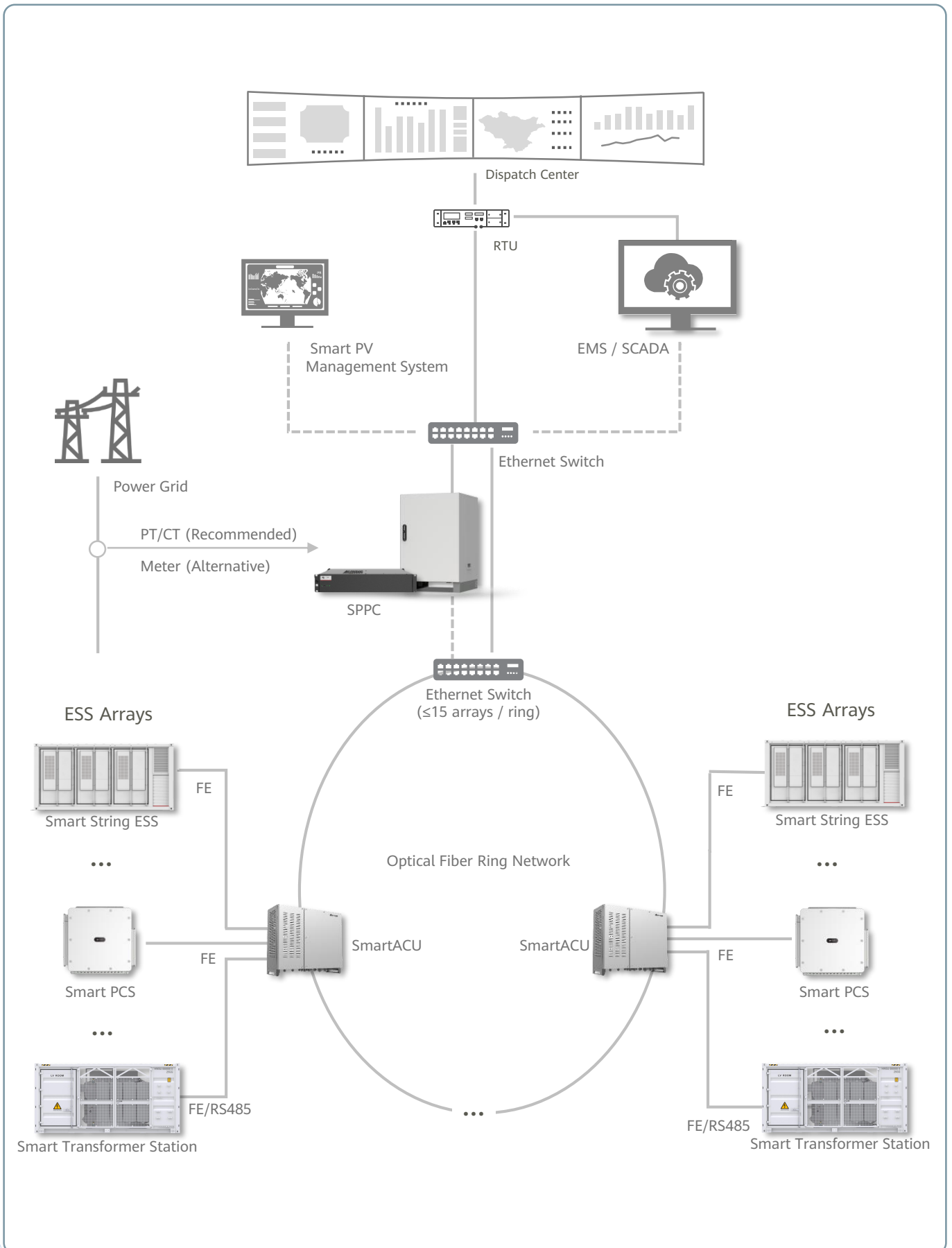

Smart PV Management System

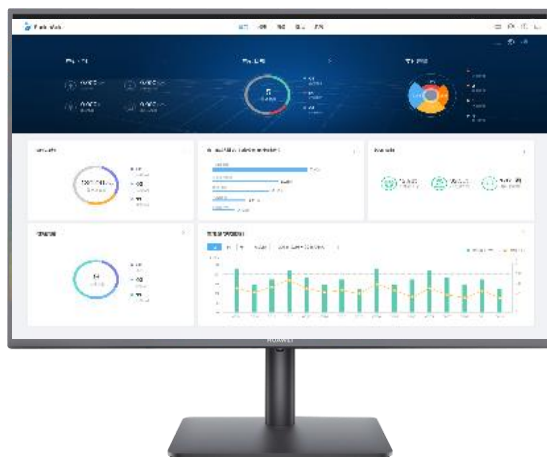

Refined

- Multi-level management, from plant-level to string/battery cell-level



Efficient

- Alarm classification and providing handling advice
- Check the status of the power station per APP



Safe

- Smart ESS Early warning of thermal runaway, minimizing the risk



Friendly

- Unified management of power stations
- 3D View of ESS

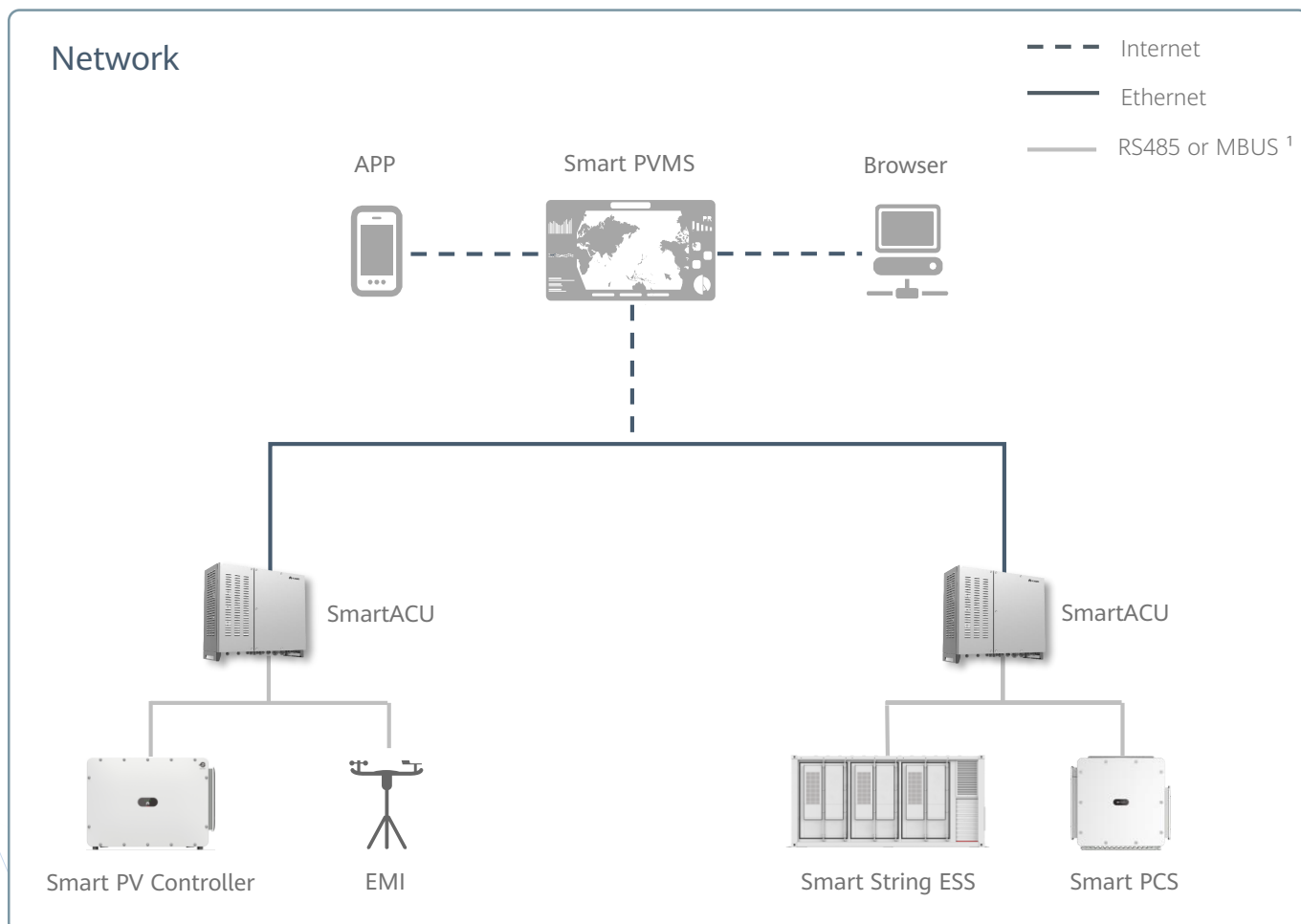

1 - Compatible with communication mode of PLC (Power Line Communication).

Smart PV Plant Management System



Refined

Multi-level management, from plant-level to string/battery cell-level



Efficient

Quick location of abnormal strings
Fault alarms via E-mail



Simple

Quick Construction
3D View of ESS

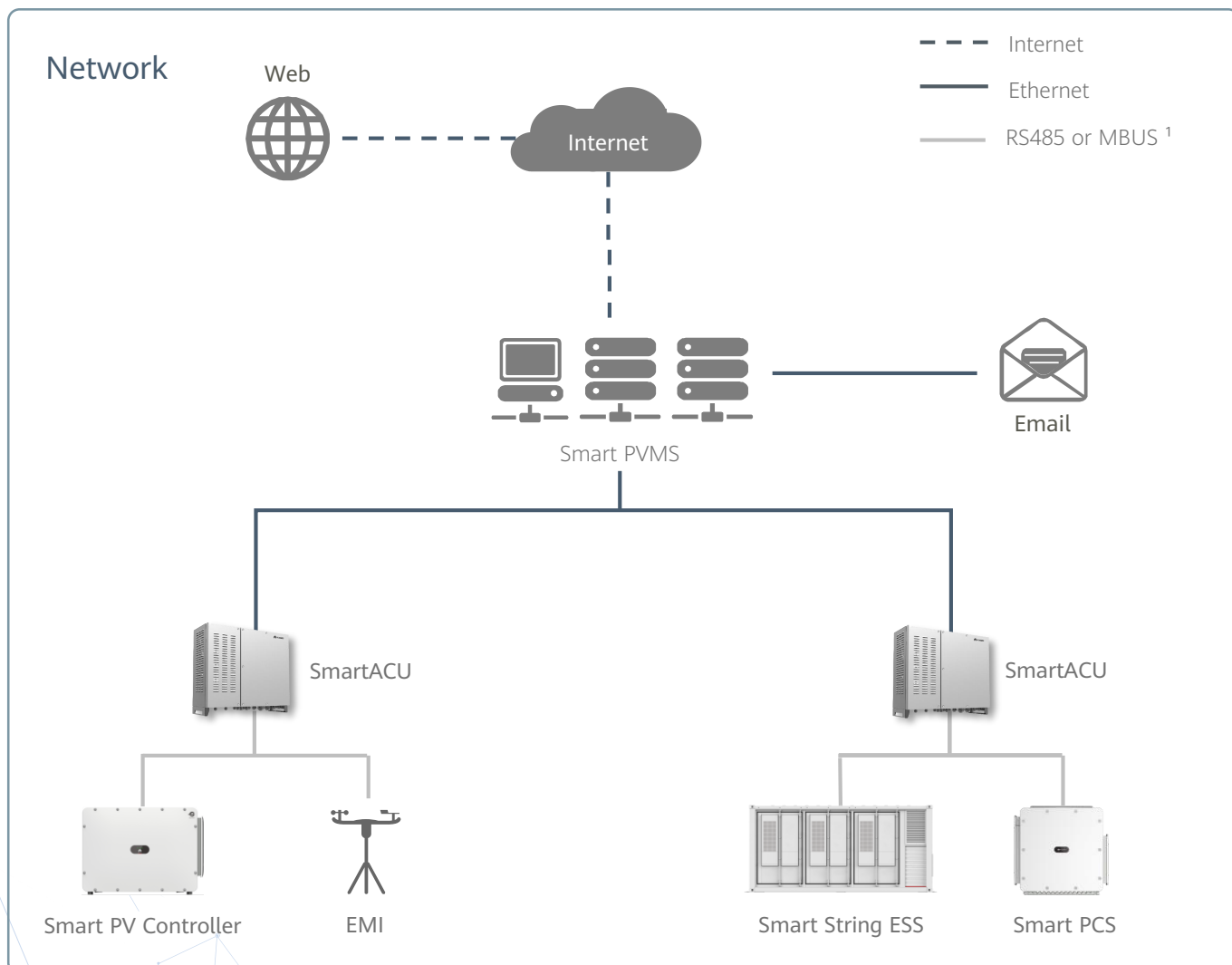

1 - Compatible with communication mode of PLC (Power Line Communication).

Smart PVMS Server Standard Version



10000 Equivalent devices supported



Software pre-installation, saving installation time by 70%



3D View of BESS
Easier and faster fault location

Technical Specification	FusionServer Pro 2288X V5 H22X-05
Max. Devices Supported	10,000 equivalent devices
Form Factor	2U rack server
Processors	2 * Intel Xeon Silver 4208 (2.1 GHz / 8-Core / 11 MB)
Memory	2 * 32 GB DDR4 RDIMM, ECC
Internal Storage	2 * 1.2 TB, SAS 2.5" HDD, 10,000 RPM
Operating System	Euler OS
Database	Gauss DB
RAID Support	RAID 1
Network Ports	Two PCIe NICs, each supporting four GE electrical ports
Power Supply Units	2 hot-swappable PSUs, 1+1 redundancy
Power Supply	Input: 100-240 V _{AC} / 11~5.5 A ; 240 V _{DC} / 5 A
Fan Modules	4 hot-swappable counter-rotating fan modules, N+1 redundancy
Operating Temperature	5°C ~ 40°C
Dimensions (H x W x D)	86.1 x 447 x 748 mm
Weight	29 kg
Standards Compliance	
RoHS, CE, UL, FCC, CCC, etc.	

Smart PVMS Server Premium Version



30000 Equivalent devices supported



Software pre-installation, saving installation time by 70%



3D View of BESS
Easier and faster fault location

Technical Specification	FusionServer Pro 2288X V5
Max. Devices Supported	30,000 equivalent devices
Form Factor	2U rack server
Processors	2 * Intel Xeon Gold 5218 (2.3 GHz / 16-Core / 22 MB)
Memory	4 * 32 GB DDR4 RDIMM, ECC
Internal Storage	2 * 1.2 TB + 8 * 1.8 TB, SAS 2.5" HDD, 10,000 RPM
Operating System	Euler OS
Database	Gauss DB
RAID Support	RAID 1, RAID 10
Network Ports	Two PCIe NICs, each supporting four GE electrical ports
Power Supply Units	2 hot-swappable PSUs, 1+1 redundancy
Power Supply	Input: 100-240 V _{AC} / 11~5.5 A ; 240 V _{DC} / 5 A
Fan Modules	4 hot-swappable counter-rotating fan modules, N+1 redundancy
Operating Temperature	5°C ~ 40°C
Dimensions (H x W x D)	86.1 x 447 x 748 mm
Weight	30 kg
Standards Compliance	
RoHS, CE, UL, FCC, CCC, etc.	

Success Cases



25MW/50MWh

First Large Scale String Inverter + String Energy Storage Demonstration Project in Hainan

Solution Configuration

- 25 x LUNA2000-2.0MWH-2H1
- 125 x LUNA2000-200KTL-H0

COD: Apr, 2022

Location: Hainan, China



115MW/146MWh

Spinning Reserve, Frequency Regulation

Solution Configuration

- 73 x LUNA2000-2.0MWH-1H1
- 575 x LUNA2000-200KTL-H0

COD: Nov, 2022

Location: Singapore

Success Cases



100MW/200MWh

60MW/120MWh Power grid side +
40MW/80MWh User side

Solution Configuration

- 100 x LUNA2000-2.0MWH-2H1
- 500 x LUNA2000-200KTL-H0

COD: Dec, 2022

Location: Hubei, China



1.6MW/8MWh

Stable power supply ensures
continuous production

Solution Configuration

- 4 x LUNA2000-2.0MWH-2H0
- 8 x LUNA2000-200KTL-H0

COD: Mar, 2022

Location: Jiangsu, China

Success Cases



400 MW PV + 1.3 GWh BESS

World's largest microgrid in Saudi Arabia

COD: Dec., 2022 (Phase I)

Location: Saudi Arabia

Solution Configuration

- 1890 x SUN2000-200KTL-H2
- 1318 x LUNA2000-200KTL-H1
- 605 x LUNA2000-2.0MWH-4H1
- 2 x LUNA2000-1.0MWH-1H1
- 30 x JUPITER-9000K-H0, 6 x STS-3000K-H1



0.7 MW PV + 1MWh BESS

Enterprise green power supply & disaster back up

COD: Dec, 2022

Location: Japan

Solution Configuration



- 5 x SUN2000-125KTL-JPH0
- 1 x LUNA2000-1.0MWH-1H1
- 3 x LUNA2000-100KTL-NHH1



Copyright © Huawei Technologies Co., Ltd. 2023. All rights reserved.

No part of this document may be reproduced or transmitted in any form or by any means without prior written consent of Huawei Technologies Co., Ltd.

Trademark Notice

 , HUAWEI, and  are trademarks or registered trademarks of Huawei Technologies Co., Ltd. Other trademarks, product, service and company names mentioned are the property of their respective owners.

General Disclaimer

The information in this document may contain predictive statements including, without limitation, statements regarding the future financial and operating results, future product portfolio, new technology, etc. There are a number of factors that could cause actual results and developments to differ materially from those expressed or implied in the predictive statements. Therefore, such information is provided for reference purpose only and constitutes neither an offer nor an acceptance. Huawei may change the information at any time without notice.

HUAWEI TECHNOLOGIES CO., LTD.

Huawei Industrial Base, Bantian Longgang
Shenzhen 518129, P.R. China
Tel: 400-822-9999
Solar.Huawei.com

The text and figures reflect the current technical state at the time of printing. Subject to technical changes. Errors and omissions excepted. Huawei assumes no liability for mistakes or printing errors. For more information, please visit solar.huawei.com. Version No.:01-(202304)