



System and Grid Connection Safety

Technologies for PV Plants

White Paper



HUAWEI

Copyright © 2023 Huawei Digital Power Technologies Co., Ltd. All rights reserved.

No part of this document may be reproduced or transmitted in any form or by any means without prior written consent of Huawei Digital Power Technologies Co., Ltd.

Trademark Notice

☀️ HUAWEI and ☀️ are trademarks or registered trademarks of Huawei Technologies Co., Ltd. Other trademarks, product, service and company names mentioned are the property of their respective owners.

General Disclaimer

The information in this document may contain predictive statements including, without limitation, statements regarding the future financial and operating results, future product portfolio, new technology, etc. There are a number of factors that could cause actual results and developments to differ materially from those expressed or implied in the predictive statements. Therefore, such information is provided for reference purpose only and constitutes neither an offer nor an acceptance. Huawei Digital Power Technologies Co., Ltd. may change the information at any time without notice.

HUAWEI DIGITAL POWER TECHNOLOGIES CO., LTD.

Antuoshan Headquarters Towers, 33 Antuoshan 6th Road, Futian District, Shenzhen, P.R.C.

solar.huawei.com

Contents

Background 02

PV Plant Safety Issues and Typical Cases 04

01 Typical Faults on Equipment	06
Ground Fault.....	06
DC Power Reverse Connection	06
Connector Contact Fault.....	06
AC Arc Fault	07
AC Insulation Fault.....	07
02 Typical Faults on Power Grids	08
Equipment Safety Problems Caused by Power Grid HVRT	08
Equipment Safety Problems Caused by Power Grid LVRT	08
Equipment Safety Problems Caused by Poor Harmonic Control at a Low SCR.....	08
Equipment Safety Problems Caused by Wideband Oscillation	10

Safety Design for PV Plant Systems and Grid Connection 11

01 Safety Design Concept	12
02 Design Framework and Technology for Electrical Safety in PV Plants	12
Equipment and System Safety	13
Technical Requirements and Design for Grid Connection Safety of Power Plants	19

Safety Applications & Success Stories 23

01 Equipment System Safety Applications & Success Stories	24
Success Stories of Smart String-Level Disconnection (SSLD) in Plateau Scenarios.....	24
Success Stories of Insulation Monitoring and Location Technology in Offshore/Floating Scenarios.....	25
Success Stories of Smart Connector-Level Detection (SCLD) Technology in Desert Scenarios	26
AC Safety Applications and Success Stories.....	27
02 Grid Connection Safety Applications & Success Stories	28
Grid Connection Support Success Stories.....	28
Grid-Forming Support Success Stories.....	29

Summary 30

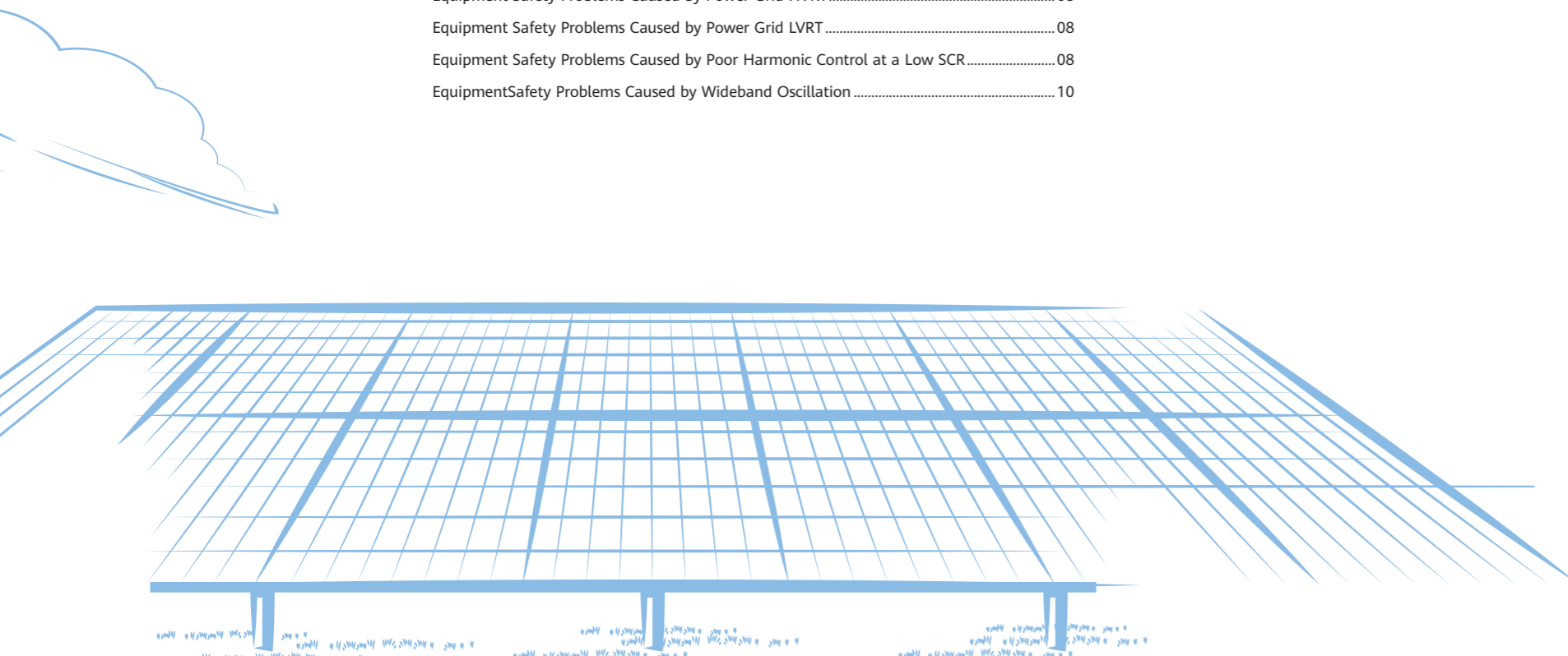



Background

The year 2023 witnessed accelerated development of renewable energy. A series of support policies have been implemented in the PV field, opening up a broad market space for PV. Driven by policies, businesses, and technologies, the PV industry developed rapidly in 2023. The market value is doubled in application scenarios such as plateaus, deserts, wastelands, agrivoltaics, hydrovoltaics, and floatovoltaics, driving PV to become a main energy source. According to the forecast of BloombergNEF, the annual average installed capacity will exceed 700 GW for the period 2025–2030, and the global cumulative installed PV capacity will reach 6.7 TW by 2030.

While renewable energy is developing rapidly, challenges increase over time as the design, construction, and operations of utility-scale plants are in uncharted waters. The challenges vary with the development of the industry, forcing us to achieve comprehensive improvement in the grid integration of renewable energy, the safety of power supply, equipment, and production, land use, quality, and O&M, in addition to reducing the levelized cost of electricity (LCOE).

Safety underpins the reliable operations of PV plants throughout the process from construction to O&M of numerous renewable energy equipment. In 2023, Huawei and China General Certification Center (CGC) jointly released the White Paper on Smart Safety Technology for PV Plants. The white paper comprehensively analyzes the electrical safety issues and incidents of PV plants, and systematically elaborates the latest technologies and practices in PV plant safety protection. It is helpful to the application of smart safety protection technologies for PV plants and is widely recognized. While driving the industry toward technologies such as smart string-level disconnection (SSLD) and smart connector-level detection (SCLD), related safety features have also been adopted in industry standards, such as the Technical Requirements for Photovoltaic Power Stations in Desert Areas.

Huawei has refined the safety features based on its continuous research and insights, and has also carried out empirical tests, comparisons, and GW-level extensive applications in PV plants. We believe that static safety of equipment alone is insufficient to ensure the electrical safety of the entire system. Safety protection against power grid faults after equipment is connected to the power grid must also be implemented to ensure dynamic operation safety and grid safety. In this way, PV plants can be safely and stably connected to the power grid throughout their life cycle.

This white paper classifies safety features into different levels by specific metrics to help establish unified evaluation standards on PV plant safety, ultimately promoting the healthy and stable development of the PV industry.

the annual average installed capacity will exceed 700 GW for the period 2025–2030



700 GW

the global cumulative installed PV capacity will reach



6.7 TW



PV Plant Safety Issues and Typical Cases

As semiconductor devices such as N-type PV modules and IGBTs develop further, the power density of key PV plant equipment such as PV modules and inverters keeps increasing, which may lead to more safety risks and worse consequences. Moreover, utility-scale plants are deployed not just on flat grounds but also in complex environments such as deserts, wastelands, mountains, offshore areas, and plateaus. The varying environment characteristics make safety issues more prominent.



In agrivoltaics scenarios, special geological conditions may cause structure deformation and connector disconnection. As a result, the voltage on both sides of a connector may break down the air and causes arcing. The temperature of DC arcing can reach 3000°C instantaneously, resulting connector burning or even worse consequences. The following figure shows contact deterioration due to long-term impact of strong winds and land subsidence.



> Poor contact of connectors due to land subsidence



Insulation failure is one of the major safety risks in offshore and other areas with high humidity and salt fog. Insulation failure is mainly caused when the performance of insulation materials decreases due to a combination of electric field, thermal, and chemical factors. The main form of insulation failure is insulation breakdown. When the electric field strength applied to the dielectric is higher than the critical value or reaches a certain level, the insulation resistance of the dielectric will be lower than the critical value. As a result, the current passing through the dielectric surges, causing insulation failure. This phenomenon is also called dielectric breakdown, which can lead to serious consequences such as fire. In offshore scenarios, DC cables, junction boxes, AC cables, and wiring terminals are prone to corrosion, which may compromise the insulation performance. For example, creepage distance reduction may cause insulation failure or overheat of inverter boards or modules, resulting in sparks and even inverter burning.

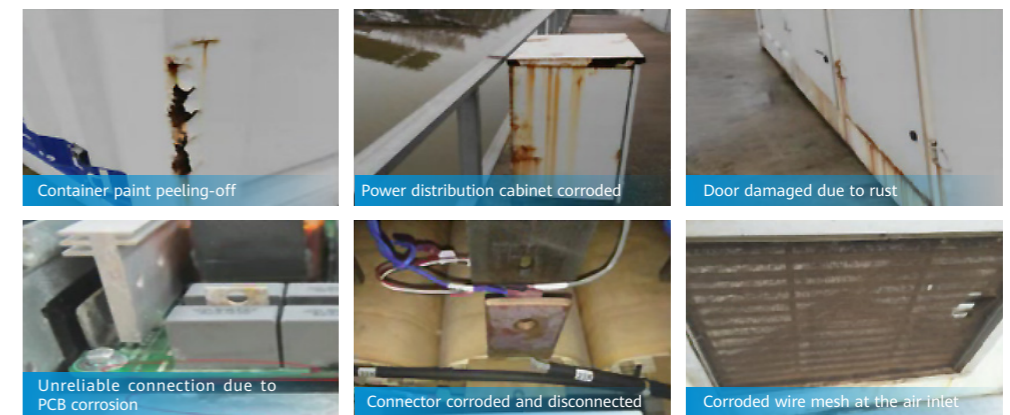

> Equipment corrosion in an offshore scenario

In addition to the preceding scenarios, safety issues can also be caused on equipment and power grids.

01 Typical Faults on Equipment

| Ground Fault

Ground faults are the most probable and prominent safety issue in PV plants. According to the statistics of a third-party organization, more than half of PV plant fires are caused by grounding faults. In a PV plant, most cables between PV modules, combiner boxes (if any), inverters, and transformer stations are buried underground. These cables and the wiring terminals are prone to damage and come in contact with the ground. As a result, the insulation of transmission wires to the ground decreases. Once a leakage loop is formed, local heating or electric sparks will be caused, even leading to a fire.

| DC Power Reverse Connectio

A PV plant involves many long cables. During cable connection, the male and female connectors may be reversely connected, causing a DC reverse connection fault. Conventionally, when multiple strings are connected in parallel, fuses are used for overcurrent protection. If one PV string is reversely connected, the voltage of the faulty circuit may be twice the voltage of the PV string. The existing 1500 V fuse may not reliably interrupt the current, causing blowout and fire.

| Connector Contact Fault

A PV plant involves a large number of connectors. Faults caused by poor contact of connectors are also common plant safety problems. Take a 100 MW plant as an example. The plant has more than 7000 PV strings that need to be connected through more than 14,000 DC connectors. The possible causes of a connector contact fault are as follows: During connector production, the metal core is not properly crimped; during plant construction, the connector is not properly connected due to improper operations; during plant operation, external forces generate stress between connector contact points. As a result, the connector is loosely connected.

Poor contact of connectors directly causes connector overtemperature. However, because the temperature of an inverter DC connector cannot be detected, the fault may be escalated to DC arcing and even fire.

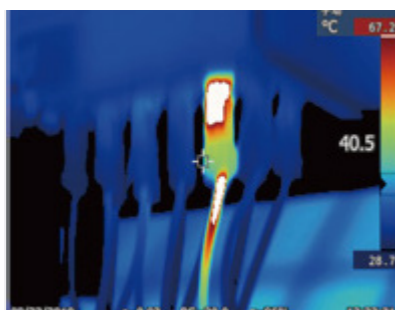

> Overtemperature due to a connector fault



> Fire caused by connector overtemperature

| AC Arc Fault

Mature technologies and comprehensive standards are available for AC protection of PV plants. However, arcing may still occur when a circuit breaker is interrupting the fault current in case of a short circuit. An arc is an ionized high-temperature gas flow. At the early stage of arc ignition, shock waves generated by air deflagration and subsequent high-temperature air flows can greatly harm human bodies and devices.



> Safety incident caused by arcing at a transformer station

| AC Insulation Fault

A renewable power plant involves a large number of cables buried underground. During cable routing and subsequent O&M, the insulation of cables may be damaged or aged. If that happens, the insulation to the ground will decrease and even a ground fault will occur. Generally, the neutral point is not grounded on the low-voltage side of a renewable power plant. Monitoring the insulation resistance of the system to the ground is essential to ensuring personal safety during O&M.



High voltage breakdown



Poor installation or connection



Corrosion due to moisture, dust, or pollution

> Medium-voltage faults at a transformer station

02 Typical Faults on Power Grid

For a power grid with a high penetration rate of renewable energy and a high proportion of power electronic equipment, insufficient control and grid support will not also decrease the stability of the power system, but also bring numerous challenges such as electrical equipment damage and electrical safety issues. Problems such as insufficient inverter hardware design capability, inverter high/low voltage ride-through (HVRT/LVRT), and poor harmonic control have occurred in several places, causing equipment faults or compromising upper-layer system protection.

Equipment Safety Problems Caused by Power Grid HVRT

When HVRT takes place on the power grid, the grid voltage will increase, which boosts the voltage on the AC side of inverters up to 1.3 times the rated voltage. For a level-1 circuit that converts DC into AC power, if there is no level-2 voltage regulator circuit that converts DC into DC power, the voltage on the DC side increases accordingly when the AC voltage of the power grid increases. As a result, the output power decreases and operational stability is affected. If the DC voltage does not increase, the AC voltage may be higher than the DC voltage, which may cause risks such as backfeed.

Equipment Safety Problems Caused by Power Grid LVRT

In 2020, a renewable power plant in Northeast China was expanded and connected to a weak grid. Some inverters failed in LVRT and were thus damaged. The incident stemmed from an inter-phase short circuit in the power grid. As a result, the A-B phase voltage was distorted, and the inverters in the plant shut down due to LVRT failure. In addition, the inverters were damaged due to reverse power flow caused by control issues. Similar problems occurred in about 35 of the 40 arrays in the power plant. Consequently, the system was shut down for two weeks, causing an energy yield loss by about 3%.

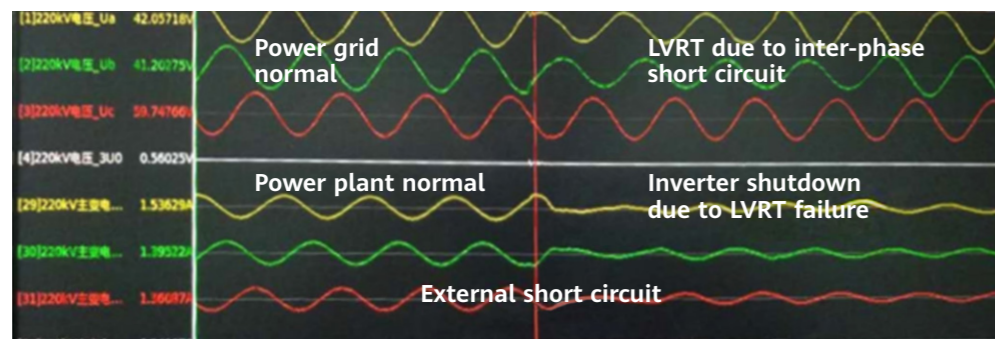

> LVRT waveforms

Equipment Safety Problems Caused by Poor Harmonic Control at a Low SCR

Large harmonics have caused multiple faults such as circuit breaker tripping and equipment damage in China. Especially in distributed power plants, harmonic problems are prominent due to local heavy loads.

Case

In a PV plant in South China, about 100 inverters from a vendor reported alarms in a morning and the box cover bulged. Most MCCBs on the low-voltage side of the transformer station tripped and had traces of arcing. After investigation, it was found that high-order harmonics and voltage spikes were generated on the 35 kV power grid

> Fault scene of a PV plant in South China

Case

In a distributed PV plant in Zhejiang province, inverters produced high grid connection harmonics and voltage spikes. As a result, many AC SPDs of inverters were damaged, causing transformer station tripping and equipment damage.

> Large grid connection harmonics and equipment damage in a PV plant in Zhejiang

Case

In a PV project in Northwest China, harmonic oscillation occurred on the 35 kV side. As a result, some equipment such as the voltage transformer in the plant was damaged and the circuit breakers tripped.

> Fault waveforms of a PV project in Northwest China

Case

In a distributed power plant in Jiangsu province, many internal LC filter circuits were faulty due to certain background harmonics from the power grid and poor inverter control and harmonic tolerance capabilities.

> Poor harmonic tolerance capability causing faults in many internal LC filter circuits in a PV project in Jiangsu

The grid-connected inverters and SVG equipment provide insufficient harmonic control capabilities. As a result, equipment shutdown and other system oscillation problems occurred for multiple times. To address the challenge, grid-connected PV equipment must provide strong harmonic tolerance and suppression capabilities under different power grid working conditions.

Equipment Safety Problems Caused by Wideband Oscillation

Along with the increasing proportion of renewable energy, weak or even negative damping may occur on a wider frequency band among power electronic equipment and between the equipment and the power grid due to the joint effect of multiple power regulation equipment. As a result, the electrical energy fluctuates overtime, causing wide-band oscillation. After large-scale renewable energy is connected to the power grid, system oscillation will be more challenging due to the use of multiple control modes in power electronic equipment.

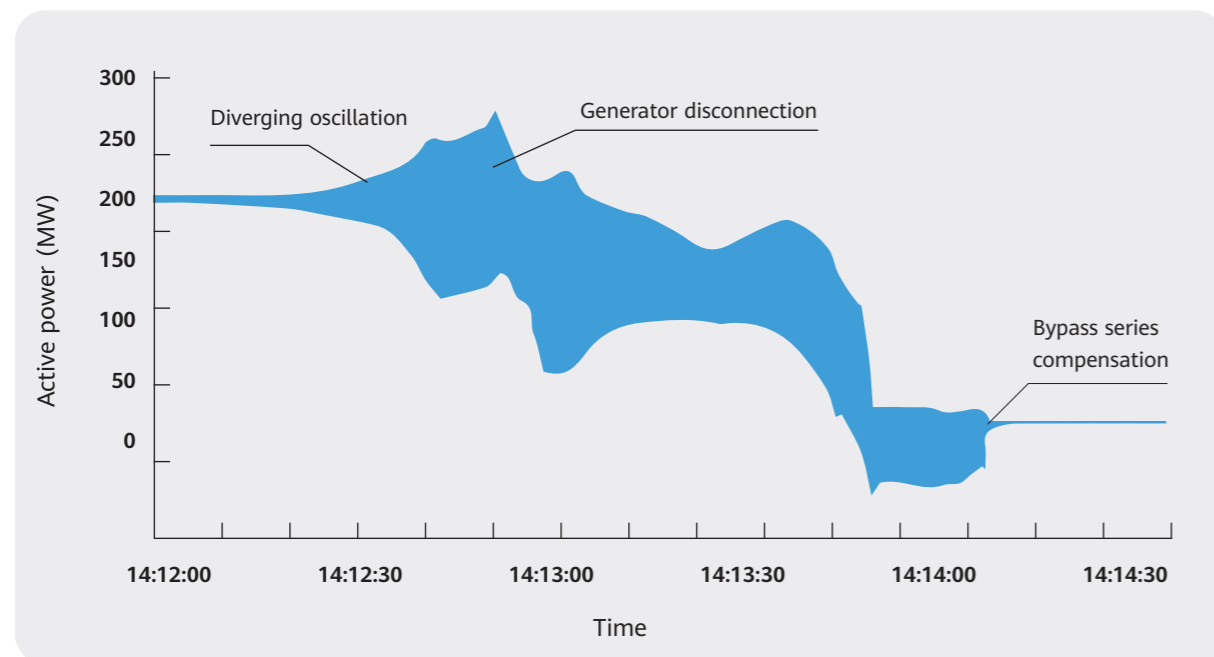

> Power oscillation of a wind farm in Guyuan, Hebei province

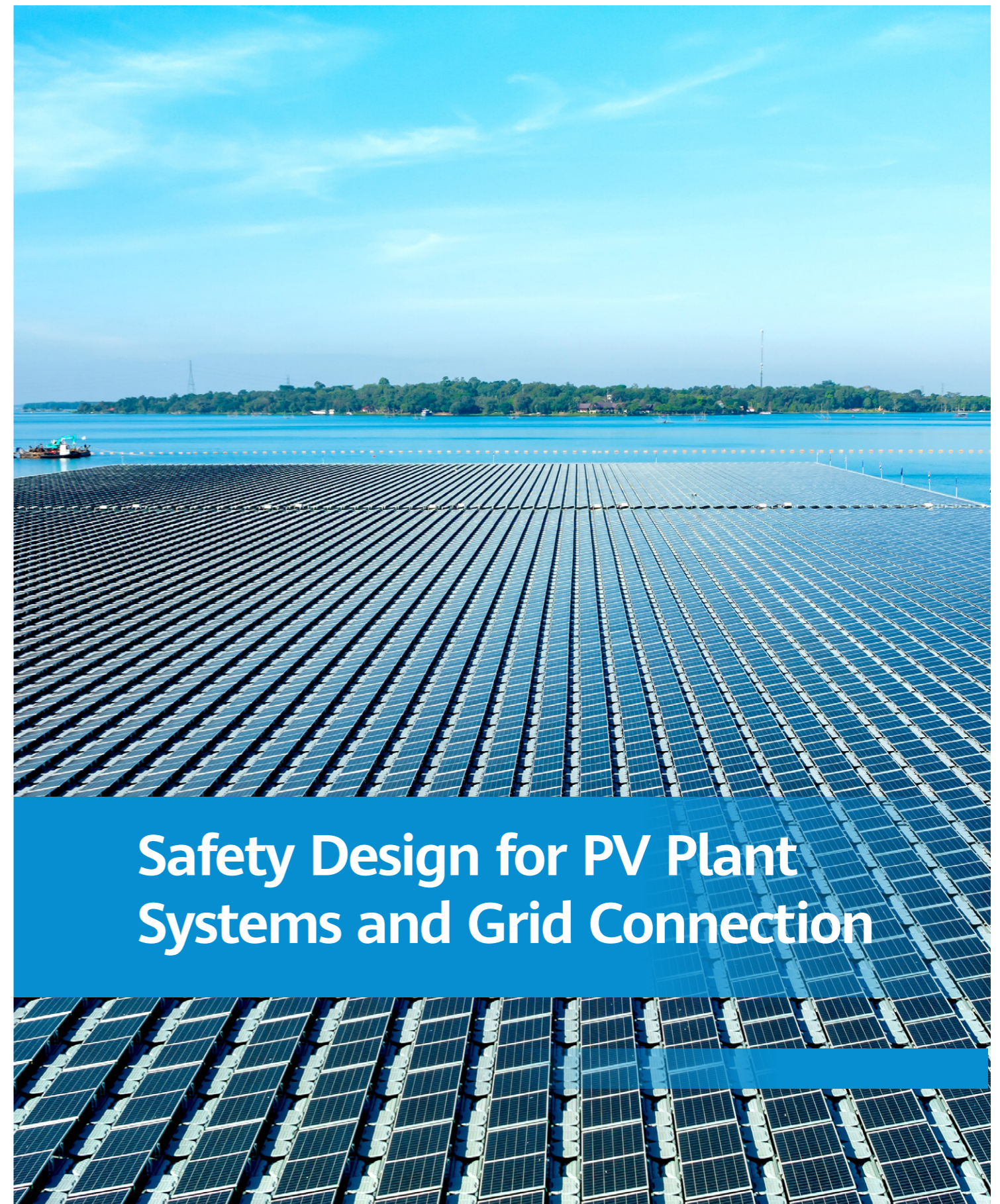

Safety Design for PV Plant Systems and Grid Connection

01 Safety Design Concept

Electrical faults in PV plants take in different forms and are caused by complex factors. The causes of electrical safety faults not only exist in equipment, but also the entire system such as the power grid after the equipment is connected to the grid. Systematic safety planning and protection in design, equipment, construction, and operations must be implemented to prevent safety incidents.

02 Design Framework and Technology for Electrical Safety in PV Plants

In addition to system safety improvement using digital and intelligent methods, we propose more safety features such as intelligent insulation monitoring and protection and equipment safety protection against power grid faults. All these measures aim to ensure internal and external reliability of PV plants.

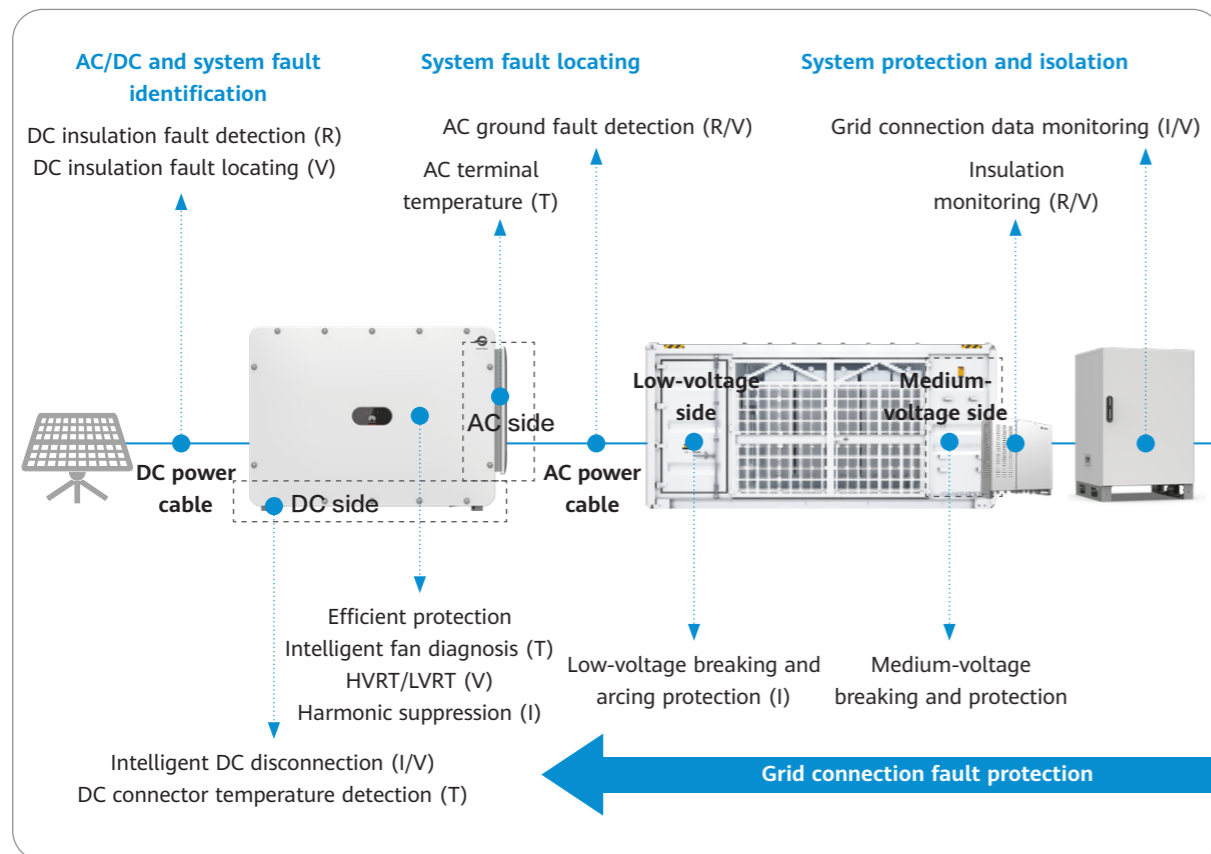

> Comprehensive safety diagnosis based on data such as current, voltage, impedance, and temperature (I/V/R/T)

Equipment and System Safety

Insulation Monitoring and Locating Technology

Insulation failure is a common fault in PV plants, especially in floatovoltaics, hydrovoltaics, mountainous areas, and other environments with high humidity and temperature.

According to section 7.10.1 in the NB 32004 standard, an inverter connected to an ungrounded PV array must measure the insulation resistance between the PV array input and the ground before the system is started. If the impedance is less than $U_{maxpv}/30 \text{ mA}$ (U_{maxpv} is the maximum output voltage of a PV array), the inverter must report an alarm. If the inverter is not electrically isolated, it cannot be connected to the grid.

Before the system is started, PV inverters test whether the ground insulation meets the requirement. If an insulation fault occurs, the inverter reports an alarm and can be located. However, inverters cannot determine specific fault points. Therefore, the faults need to be located by O&M personnel with safety ensured. The increasing power of PV inverters and increasing number of PV strings make troubleshooting much more difficult and time-consuming.

Huawei proposes digital and intelligent methods as well as the insulation monitoring and locating technology. When detecting that the insulation resistance to the ground is low, an inverter automatically starts insulation locating. By intelligently sensing voltage changes, the inverter automatically locates the MPPT circuit where the fault exists and identifies the location of the fault in the PV string. This solution significantly shortens the fault locating time and protects customers' assets and personal safety. It provides instructions for onsite O&M personnel to rectify faults through point-to-point secondary fault identification, making troubleshooting easy in a large PV plant that involves numerous devices.

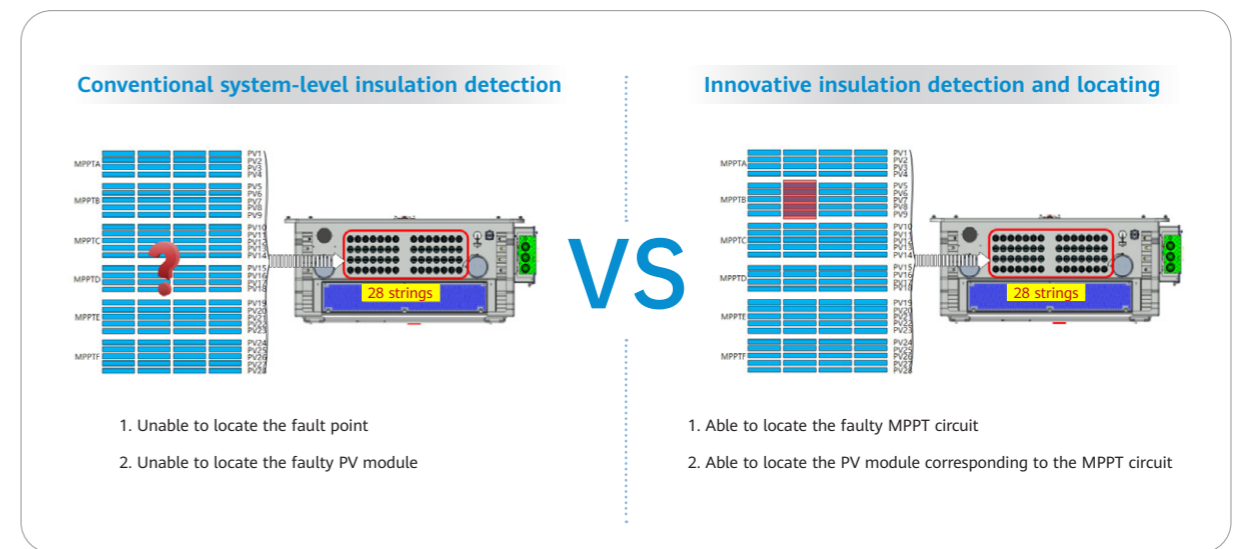

> Comparison between conventional insulation detection and innovative insulation locating

CGC, together with Huawei and related companies, has incorporated this feature into specifications and certification requirements. Insulation faults can be located in arrays, inverters, MPPT circuits, and PV modules.

Level	Standard	Positioning Accuracy (%)	Success Rate
L1	Array level: locating arrays	100	100%
L2	Inverter level: locating inverters	100	100%
L3	MPPT level: automatically locating MPPT circuits	100	100%
L4	Module level: automatically locating the faulty MPPT circuit and fault point	±2 PV modules	100%
L5	Reserved	Reserved	Reserved

> Classification standards for insulation monitoring and locating technology



In 2024, Huawei received the first highest level 4 certificate for insulation locating from CGC.

Module-level certificate is achieved by combining the device function with onsite operations.

Smart Connector-Level Detection Technology

In a conventional solution, DC connectors are mounted on external mechanical parts of an inverter. Cable harnesses connect the DC connectors to DC switches, and then to the PCB. The conventional solution features simple design and manufacturing. DC connectors need to be perforated, positioned, and fastened one by one, and pins need to be manually inserted after insulation parts are fastened, resulting in low efficiency and improper insertion. Once a connector is loose or damaged, the temperature at the involved point will increase abnormally. The inverter will detect the abnormality only when the heat damages the insulation or melts the conductor and causes arcing. In that case, the equipment may be damaged, cables may be burnt, or even a fire may occur, which would cause huge loss.

Poor contact due to improper connection of DC connectors, poor crimping, uneven foundation settlement, or corrosion may cause abnormal temperature rise, which could result in equipment burning. To solve the problem, Huawei innovatively adopts an on-board design in which connectors are inserted into a PCB and fastened by wave soldering, eliminating the need for manual pin insertion and wire routing. The design prevents the risk of loose connection of DC connectors caused by improper manual wire routing, simplifies the electrical connection process, and ensures high reliability in design and manufacturing. After the connectors are mounted on the PCB, NTC sensors can be added near the through-current points of the connectors. In this way, data can be collected, which is the prerequisite for digital and intelligent connector monitoring. The collected data is then transmitted through the signal line on the PCB, and the chip implements signal detection, data

computing, and processing to intelligently detect the connector temperature. Connector temperature detection is performed in real time. If the temperature of an AC or DC connector becomes abnormal due to improper connection, poor metal core crimping, or poor contact caused by external forces, the inverter determines the situation and triggers protection to prevent the fault from deteriorating and spreading, thus ensuring the safety of plant equipment and properties.

Intelligent connector temperature detection has been set as a standard, with four levels defined based on the protection range and precision.

Item	Level	Level 1	Level 2	Level 3	Level 4	Level 5
Detection rang	Detection type	DC input connectors	DC input connectors	DC input connectors and AC output connectors	DC input connectors and AC output connectors	Reserved
	Sampling point quantity	60% of connectors	80% of connectors	80% of connectors	100% of connectors	
	Voltage range ¹	Entire voltage range	Entire voltage range	Entire voltage range	Entire voltage range	
	Current range ²	Entire current range	Entire current range	Entire current range	Entire current range	
	Temperature range ³	Entire operating temperature range	Entire operating temperature range	Entire operating temperature range	Entire operating temperature range	
Temperature output resolution	MPPT level	MPPT level	MPPT level	MPPT level	Reserved	
Temperature measurement tolerance		±5°C	±4°C	±3°C	±2°C	
Protection	Protection temperature precision	±5%/±5°C	±5%/±5°C	±2%/±2°C	±2%/±2°C	
	Protection temperature consistency	95%	96%	97%	98%	
	Protection time precision ⁴	±5%/±5s	±5%/±5s	±2%/±2s	±2%/±2s	
	Protection time consistency ⁵	95%	96%	97%	98%	
	Accuracy	100%	100%	100%	100%	

Note 1: The voltage range refers to the DC input voltage range and AC output voltage range of the power conversion equipment.

Note 2: The current range refers to the DC input current range (0 to maximum input current) and AC output current range (0 to maximum output current) of the power conversion equipment.

Note 3: The temperature range refers to the operating temperature range of the power conversion equipment.

Note 4: Precision = (Measured protection value - Expected protection value)/Expected protection value x 100%

Note 5: Consistency = STDEV [(Precision 1 - Average value)/Average value: (Precision N - Average value)/Average value]

> Comprehensive ratings of connector detection



In 2024, Huawei received the first highest level 4 certificate for connector detection from CGC.

Smart String-level Disconnection Technology

Huawei's Smart String-Level Disconnection (SSLD) technology implements active disconnection on the DC side and precise string-level protection. The technology consists of three parts: inverter detection and logic judgment system, tripping control system, and trippable DC switch system. Based on conventional switches, the trippable DC switch system is added with an energy storage module, control command interface, status feedback interface, reset button, and the innovative electronic release (generally, the electromagnetic release and thermal release are used for overcurrent protection). The technology can accurately capture slight changes of parameters such as the current and voltage. Based on a complete set of logic and algorithms, it can effectively identify faults such as PV string reverse connection, current backfeed, and bus short circuit, and protect the system from these faults.

In 2021, Huawei received the first highest-level (level I) certificate for SSLD from CGC.

Level	Level I	Level II
Current	Setting ±2%	Setting ±5%
Time	Setting ±2%	Setting ±5%

> [Breaking precision classification standards](#)

In 2023, Huawei obtained the world's first SSLD CB certificate and the world's first certificate for SSLD in compliance with circuit breaker standards, issued by Intertek and DEKRA, respectively. The two organizations have certified that Huawei's SSLD complies with IEC 60947-2.

Arc-Fault Circuit Protection Technology for Transformer Stations

Protection technologies for the AC side of PV plants are mature and related standards are well-developed. However, when a downstream molded case circuit breaker (MCCB) is disconnected due to short circuits, other low-voltage circuits or low-voltage buses are affected by arcs, escalating the accident.

To solve this issue, Huawei optimizes the design of low-voltage cabinets in its Smart Transformer Station (STS) as follows:

▶ To eliminate arc-fault spreading during fault disconnection, arc chutes with deionization grids are added to MCCBs to extinguish arcs by reducing the arc temperature and reduce the conductive particles ejected from the MCCBs.

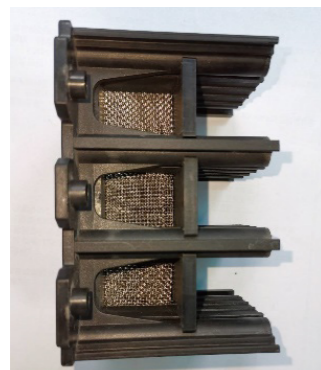

Clause	Requirement + Test	Result - Remark	Verdict
8.3.5.3	Test of rated ultimate short-circuit breaking capacity The test sequence of operations is O – I – CO For circuit-breaker fitted with adjustable releases, test shall be made with the current and time settings at maximum. Closing releases energized with 85% at the rated U _c (V) The circuit-breaker is mounted complete on its own support or an equivalent support. Test made in free air: Distances of the metallic screen's: (all sides) Back: 0mm Front: 0mm Top: 0mm Bottom: 0mm Left: 0mm Right: 0mm The characteristics of the metallic screen: - woven wire mesh - perforated metal - expanded metal		P P P P N/A P N/A

> [An arc chute with deionization grids](#)

▶ According to GB 7251-12-2013 (IEC 61439-1) Low-voltage switchgear and controlgear assemblies — Part 2: Power switchgear and controlgear assemblies, the low-voltage cabinet must implement internal isolation of Form 2b or higher (the functional units and cable inlet terminals are isolated from the main bus), or insulate the main busbar and branch busbars.

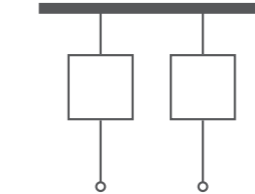

Form 1 No internal isolation



Accident without the arc-fault circuit protection technology in a power plant

VS

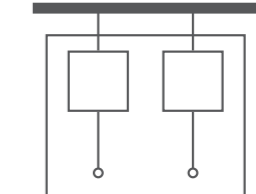

Form 2b Isolated bus and functional units



Short-circuit disconnection test in low-voltage cabinets of Huawei's STS under arc-fault circuit protection

> [With and without arc-fault circuit protection technology in low-voltage cabinets](#)

Huawei's STS pass the Internal Arc Classification (IAC) Class C arc protection requirements in the IEC 61641 and ensure zero arc-fault spreading of MCCB faults and no influence on the normal operation of other circuits in the low-voltage cabinet, improving the overall availability of the STSs.

Conventional transformer stations use the medium-voltage arc-fault venting at the bottom, requiring the cable trench at the bottom of the medium-voltage room to be sealed onsite. The onsite construction difficulty and cost are increased. In addition, if the cable trench is not properly sealed, arcs will occur, posing safety risks to operation personnel. Huawei's STS innovates the medium-voltage top arc-fault venting design, which passes the IAC Class A test in the IEC 62271-202. The design enhances the safety of the medium-voltage system and personnel and decouples the arc-fault venting channel from the foundation, reducing the balance of system (BOS) by about CNY0.0091/W (under specified conditions).



Strong coupling between the medium-voltage bottom arc-fault venting channel and the foundation in a traditional solution

VS



Decoupling between the medium-voltage top arc-fault venting channel and the foundation in a Huawei solution

> [Comparison of arc-fault venting channel solutions](#)

Intelligent Monitoring Technology for Transformer Stations

Different from TN/TT systems, an IT system has active wires insulated from the ground. The monitoring of the insulation resistance of the system can effectively reflect the operating status of the system and equipment, and provide early warning or tripping to effectively protect the equipment and personal safety.

The potential induced degradation (PID) module developed by Huawei is compatible with the insulation monitoring device (IMD) to implement online intelligent insulation monitoring for the PV system. When an insulation fault occurs on the AC or DC side, a reliable warning or alarm is generated. The insulation resistance alarm can be linked to the air circuit breaker (ACB) of the corresponding STS winding. In this way, the IMD and PID module do not interfere each other during operation, achieving an integrated and simple system architecture.

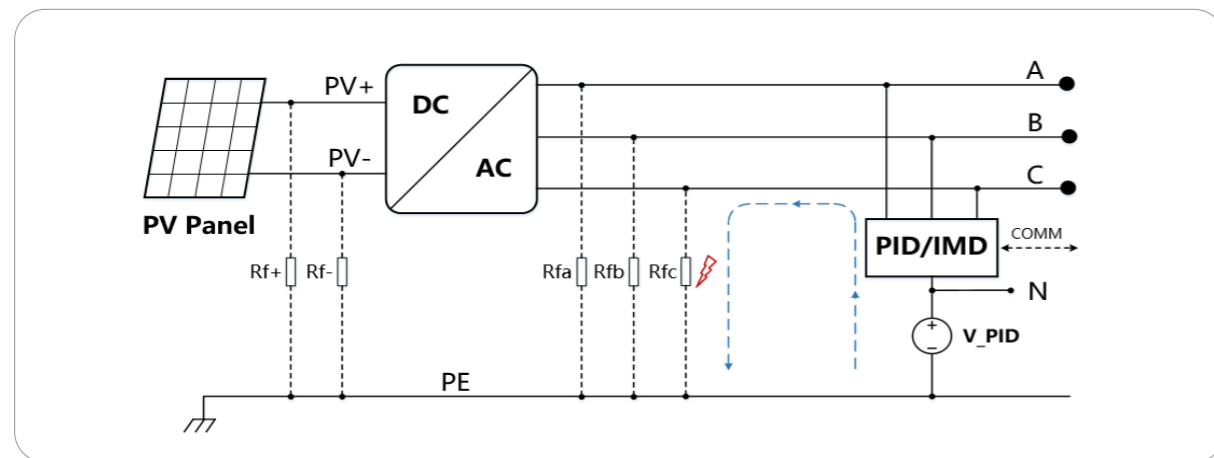

> PID+IMD system diagram

In addition, to cope with the temperature rise caused by insulation faults, Huawei's STS monitors the real-time medium-voltage cable terminal temperature and generates early warnings to ensure the safety of medium-voltage connections.

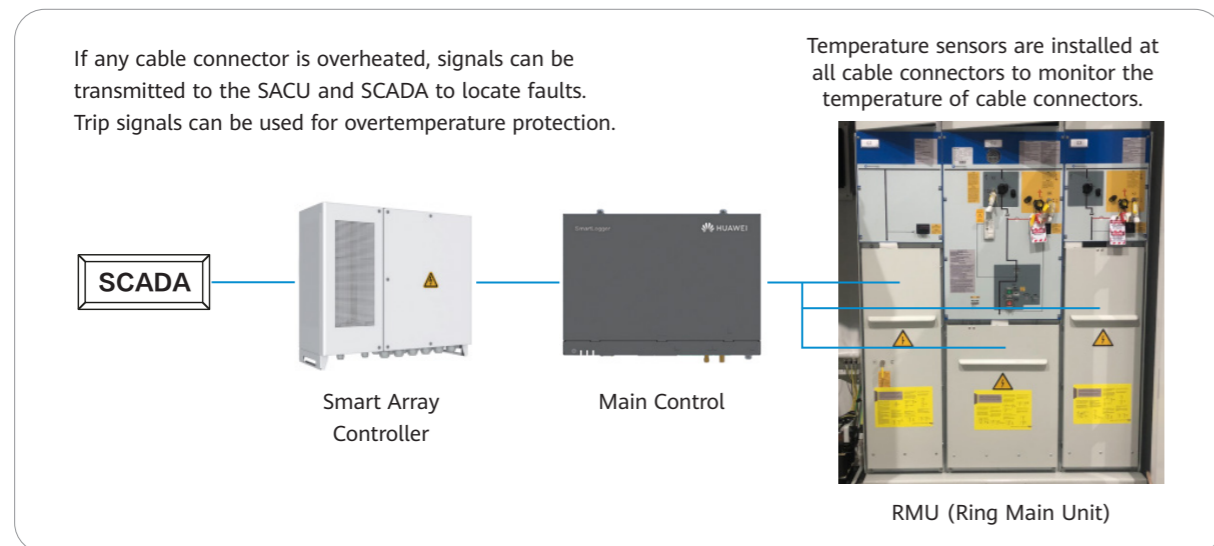

> Temperature monitoring of medium-voltage cables

Technical Requirements and Design for Grid Connection Safety of Power Plants

As the renewable energy penetration rate increases, the grid integration of renewable energy faces numerous challenges, and the requirements for grid connection safety technologies of inverters are becoming stricter.

As early as the R&D phase of each generation of Huawei inverters, the grid connection features are defined for all scenarios, and the boundary conditions and requirements for the power grid adaptability are determined: Short circuit ratio (SCR) of an extremely weak power grid = 1.05; UHV AC series compensation = 0.7; non-derated active power during high-voltage ride-through (HVRT) in UHV DC power transmission. To meet these requirements, inverters shall be under accurate monitoring and stable control.

Huawei introduces its years of experience in software algorithms and weak power grid operation in the telecom industry into the PV industry, establishes accurate mathematical models for different types of grid connection scenarios, plant design, and grid operating points, and uses big data to train the optimal grid connection control algorithm. In this way, inverters can continuously connect to the power grid and generate power in various harsh power grid waveforms. Huawei's inverters (Smart PV Controllers) adopt innovative algorithms and HiSilicon-developed chip technologies and can actively adapt to power grid changes by leveraging its advantages including high-speed processing capability, high sampling and control frequency, and control algorithms such as an advanced harmonic suppression algorithm. PV plants with Huawei's inverters have lower grid connection harmonics.

In terms of precise sensing on inverters, Huawei provides technologies of rapid phase-locking, power grid situation awareness, and active harmonic analysis. In terms of stable control, the impedance remodeling algorithm and series compensation adaptation algorithm ensure stable system power. The oscillation damping algorithm and peak voltage suppression algorithm effectively control HVRT and low-voltage ride-through (LVRT). The virtual active power filter (APF) technology and adaptive compensation technology optimize harmonic control and parallel connection harmonic suppression. The dual-stage architecture topology design supports active power non-derating during HVRT.

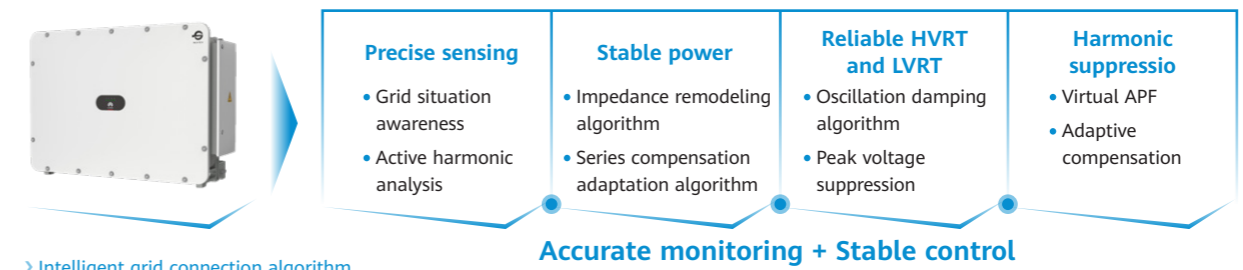

> Intelligent grid connection algorithm

Changes in Technical Requirements for Grid-Connected Plant Safety: Grid Connection Support

Active Adaptation to New GB Standards

Huawei continuously follows and adapts to the grid connection technology requirements of PV plants and inverters, and responds to and supports grid requirements in a timely manner. The GB/T 19964 was first proposed in 2005. After nearly 20 years of development, the penetration rate of renewable energy has increased, posing higher requirements on grid integration of renewable energy.

In 2014, Huawei cooperated with the China Electric Power Research Institute and the Qinghai Electric Power Research Institute in carrying out a series of tests, and passed the zero-voltage ride-through test, low-voltage ride-through test, frequency disturbance test, and power quality test in a MW-level plant, making it the world's first inverter brand that has passed the zero-voltage ride-through certification specified in GB/T 19964-2012.

In 2020, Huawei was awarded the first GB/T 37408-2019 certificate by the China Electric Power Research Institute, and Huawei inverters became the first product that passed the new GB standard in the industry. In the same year, Huawei worked with the China Electric Power Research Institute to launch the weak grid adaptability feature of PV inverters to ensure plant stability under transient and steady-state impact in extremely weak power grids, avoiding chain faults and improving renewable integration capability.

In 2024, the third edition of GB/T 19964 Technical requirements for connecting photovoltaic power station to power system was officially released. Based on years of technical experience, Huawei has quickly implemented the new GB standard. The mainstream SUN2000-300KTL-H0 model has passed the tests by the China Electric Power Research Institute and set the benchmark as the first 300+ kW high-power string inverter under the new GB standard.

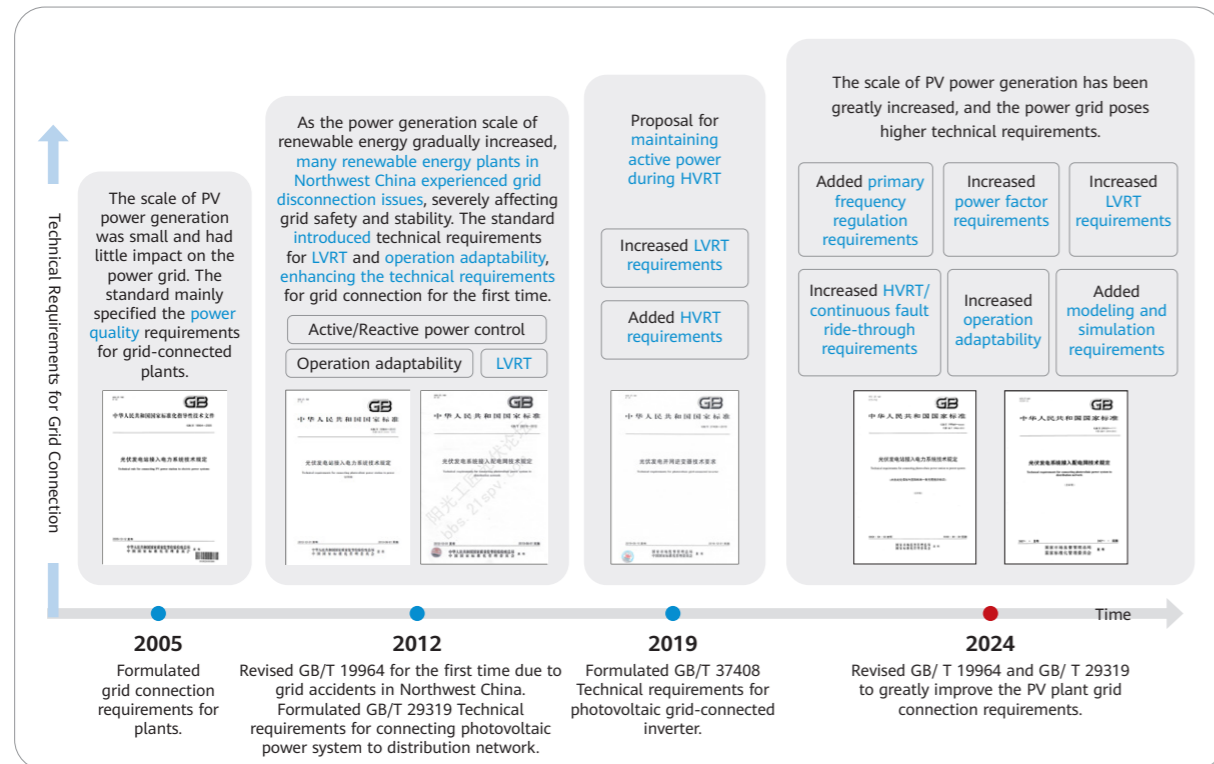

> Review of the revision history of the PV grid connection standards (grid codes)

To meet technical requirements such as HVRT, continuous HVRT/LVRT, and improve operation adaptability, Huawei's Smart String Inverter uses a two-stage conversion architecture to isolate the bus voltage from the PV voltage during grid HVRT. Even when the MPPT voltage is low in the morning and evening, or in summer, HVRT is supported within the MPPT voltage range, effectively preventing active power derating on the DC side and power grid backfeed during HVRT.

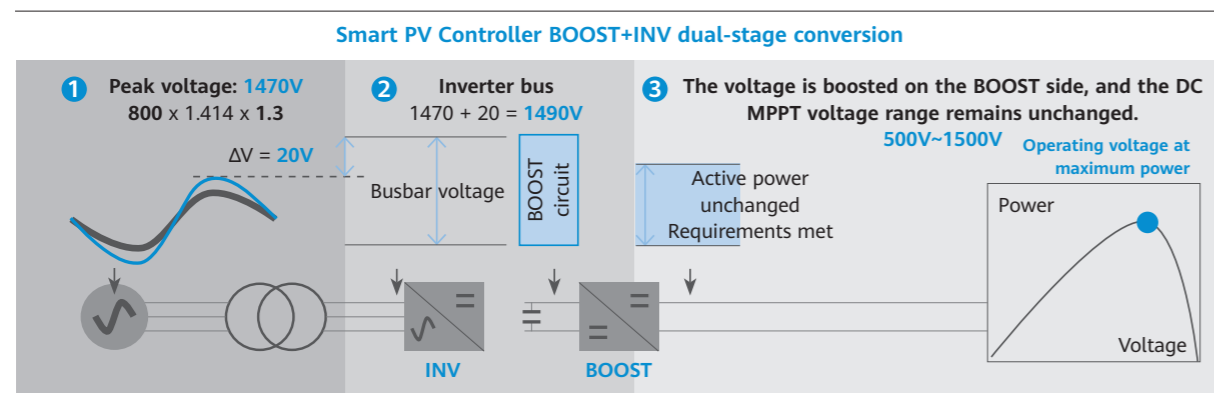

> Dual-stage architecture of the Smart PV Controller and active power without derating during HVRT

The following figure shows the typical MPPT input voltage range of PV arrays in a year from about 950 V to 1200 V, which has a wide input voltage range.

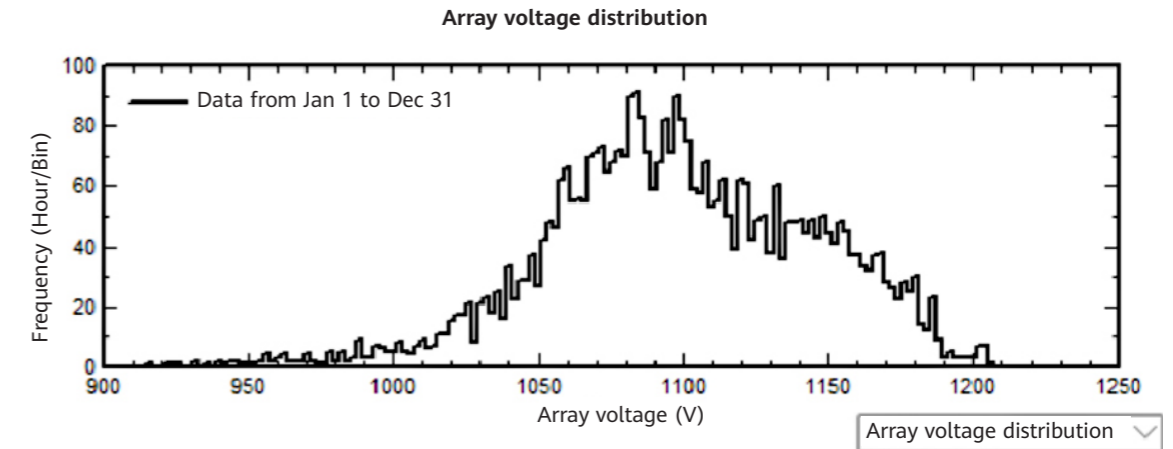

> Simulation result of a PV plant in Gonghe, Qinghai (twenty-six modules in a PV string)

Active Harmonic Suppression Technology

Huawei's inverter adopts the intelligent harmonic optimization algorithm to monitor the harmonic status of the power grid in real time and build a mirror of the power grid big data. The lightweight intelligent convergence technology and embedded intelligent algorithm are used to quickly train the inverter current control algorithm structure and parameters, ensuring the optimal solution for grid connection control. Based on the learning parameters, the output current harmonic is suppressed to the maximum extent through the wideband harmonic controller. The output current THDi of Huawei's inverter is less than 0.5% in a good power grid and less than 1% in a poor power grid, which are obviously better than the harmonic levels of a common inverter.

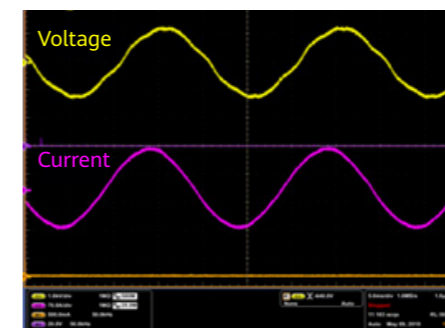

> Huawei's inverter (THDi < 1%)

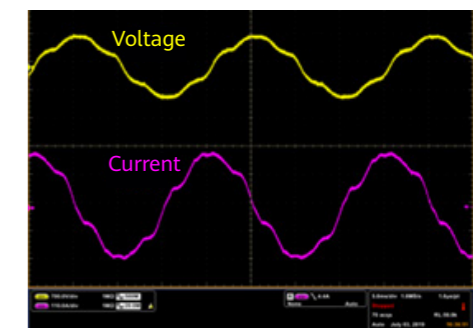

> Common PV inverter (THDi < 3%)

The intelligent stability algorithm establishes mathematical models based on a large amount of power grid operating data in normal and abnormal states, integrates intelligent self-learning algorithms, and trains intelligent grid connection algorithms through big data analysis. Especially in weak power grid scenarios, the impedance remodeling technology is added to greatly improve the robustness of the control algorithm and ensure the stability of the Smart String Inverter in complex grid connection environments such as weak power grids, series compensation, and HVDC. Huawei's inverter can run stably at full load in a weak power grid with SCR of greater than or equal to 1.05.

	Huawei's Smart String Inverter	Industry Level
Minimum SCR in weak power grids (full load)	1.05	1.5
THDi in power grids with SCR = 10	≤ 0.5%	≤ 1%
THDi in power grids with SCR = 1.5 (full load)	≤ 1%	≤ 3%
THDi in power grids with SCR = 1.2 (full load)	≤ 1%	Power-on failure

> Comparison of harmonic capabilities

Huawei's Smart PV inverter uses smart grid connection algorithms, including the intelligent harmonic optimization algorithm, intelligent stability algorithm, and intelligent fault ride-through algorithm, to greatly improve the grid connection performance of the inverter, better meet power quality requirements, better adapt to complex grid connection environments, better meet the performance requirements for fault ride-through and mid- and long-term power grid adaptability, and support a high proportion of renewable energy.

Wideband Oscillation Damping Technology

Wideband oscillations are classified into the low-frequency oscillations (0.1–2.5 Hz) and subsynchronous/supersynchronous oscillations (> 2.5 Hz).

In terms of low-frequency POD, generally, a power system stabilizer (PSS) is added to the excitation system of synchronous generators to form an additional damping control to improve the system damping and suppress low-frequency oscillation. Based on this principle, the low-frequency POD technology is introduced to the smart power plant controller (SPPC) to enable the Huawei's solution to have the PSS function of synchronous units and output additional damping control power. In this way, the low-frequency oscillation in the range of 0.1 Hz to 2.5 Hz can be damped.

To solve the subsynchronous/supersynchronous oscillation, Huawei Smart PV solution uses the adaptive virtual impedance technology to dynamically adjust the electrical characteristics of the plant through self-learning to match the power grid characteristics. In this way, the inverter and PCS can actively adjust their impedance and change the amplitude-frequency and phase-frequency characteristics of the output impedance to improve stability. This prevents power oscillation caused by insufficient damping in the subsynchronous/supersynchronous frequency bands.

Technical Design for Grid-connected Plant Safety: Grid-Forming Support

To cope with the grid challenges, Huawei has launched its innovative smart string grid-forming ESS solution by leveraging its expertise in PV, ESS, and particularly, grid-forming technologies. For details, see the Smart PV+ESS Generator White Paper.



**Safety Applications
& Success Stories**

01 Equipment System Safety Applications & Success Stories

Success Stories of Smart String-Level Disconnection (SSLD) in Plateau Scenarios

Plateau scenarios feature extremely low temperature, high altitude, and low atmospheric pressure. In addition, rugged terrains force arrays to be scattered. In a high-altitude environment with thin air, the dielectric strength of electrical devices decreases. In addition, low temperature and low atmospheric pressure reduce the reliability of devices. Scattered arrays and harsh environments make it more difficult to repair and maintain faulty devices, posing higher requirements on the active safety capability of devices in power plants.

A hydro+solar power plant in Southwest China is located at an altitude of about 4600 m and has the total capacity of 1 GW. The plant uses Huawei's Smart PV Controllers with the SSLD function. The project has been running stably since it was successfully connected to the power grid in June 2023. According to statistics, during the first quarter of 2024, Huawei helped the customer detect 5893 current backfeed alarms or disconnections, avoiding multiple problems that may cause safety accidents and ensuring the electrical safety on the DC side of the entire plant.



> A hydro+solar power plant

Success Stories of Insulation Monitoring and Location Technology in Offshore/Floating Scenarios

An insulation issue is especially prominent in offshore or floating scenarios with high humidity and heavy salt fog. High humidity and corrosion caused by heavy salt fog deteriorate the cable insulation performance. As a result, inverters generate alarms and fail to be started, bringing great challenges to the benefits and O&M of power plants. A floating power plant in Shandong Province is located in a coastal scenario. The plant contains 1600 inverters in total. At the early stage of operation, a large number of alarms such as low inverter insulation impedance were generated due to corrosion and cable disconnection. The maximum number of alarms in a month reached 17,685. About one-third of inverters triggered alarms every day on average. According to the alarm information, O&M personnel had to check the cables of PV strings one by one by visiting the inverter position by boat, bringing great difficulties and challenges to onsite O&M personnel.



> A floating plant

During traditional O&M, more than 28 PV strings and more than 56 cables need to be checked. With Huawei's insulation monitoring and location technology, only 4-5 PV strings and fewer than 10 cables need to be checked, improving fault locating precision by six times, reducing energy yield loss, and increasing O&M efficiency.

Suggestions

1. Check the output resistance of the PV array to the ground. If there is a short circuit or lack of insulation, rectify it.
2. Check that the PE cable of the device is correctly connected.
3. If the impedance is lower than the specified protection threshold in rainy and cloudy days, change the "Insulation resistance protection threshold" setting.

Fault locating status: succeeded. Current insulation resistance: 0.017 MΩ. Possible faulty PV string: MPPT3. Possible short-circuit position: 92.8%. Connect the possible faulty PV strings to the inverter one by one for troubleshooting. For details, see the user manual.



> Precise locating

> High-humidity and high-salt spray test

Success Stories of Smart Connector-Level Detection (SCLD) Technology in Desert Scenarios

Terminal fire is one of the common problems in the desert/wasteland scenario and one of the important factors that affect the safe operation of power plants. The importance of terminal temperature detection is proved in a power plant in the Kubuqi Desert, Inner Mongolia. The power plant is equipped with Huawei SUN2000-300KTL-H0 inverters and third-party 300+ kW inverters. The third-party inverters do not support terminal temperature detection, causing multiple accidents during the construction and operation of the power plant, for example:

► **Burnt inverter terminals:** The interior of an inverter was normal, but the cable was burnt due to overtemperature. According to the analysis of onsite technical experts and O&M personnel, the terminals were not properly crimped and the contact impedance was too large. As a result, the terminals were overheated and burnt. To prevent this accident from happening again, the customer needs to check whether there are poor crimping or loose connection in the plant. If yes, rectify the fault immediately.

► **Inverter breakdown due to burnt DC components:** Cables and terminals of multiple inverters were severely burnt, and the inverters broke down. According to the analysis of the onsite personnel, the external terminal was burnt due to overtemperature, and the conductive dust entered the inverters. As a result, short circuits occurred.

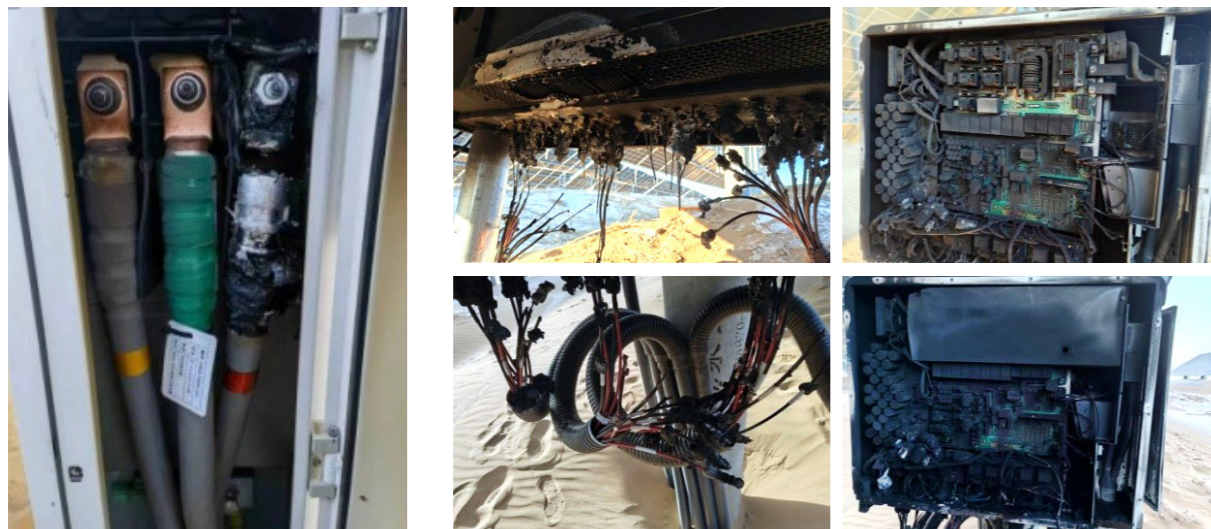

> Burnt terminals

> Inverter terminal fire caused by overtemperature

Huawei SUN2000-300KTL-H0 inverters in the same PV plant support the terminal temperature detection function, which prevents many similar problems during operation. According to the onsite personnel, from January to May 2024, 64 abnormal AC terminal issues and 119 abnormal DC terminal temperature issues have been intercepted, ensuring the safe operation of inverters by intelligent tools.

AC Safety Applications and Success Stories

AC safety is also critical. Huawei uses arc-fault circuit interrupter (AFCI) and SmartIMD technologies to ensure AC safety and O&M safety in power plants and has applied them to multiple projects, for example:

A 144 MW PV project in Mexico, a 26 MW PV plant in Spain, and a 100 MW PV plant in Vietnam all adopt Huawei's STSs. Thanks to the all-round AFCI technology, Huawei's STSs achieve zero arc-fault spreading issues and no safety accident has occurred since grid connection. In addition, the pre-integration and pre-testing eliminate the need to connect cables and configure signal points onsite, achieving fast delivery.



> A 144 MW PV project in a desert scenario in Mexico



> A 26 MW PV project in Spain



> A 50 MW PV project in Vietnam

To further enhance the safety of customers' power plants, Huawei's SmartIMD function is loaded to the PID modules by software licenses to monitor the PID-to-ground insulation resistance around the clock without affecting the normal use of the PID function. An ESS project in Singapore is equipped with Huawei's STSs. Thanks to the SmartIMD function, alarms or UPS shutdown prevents short circuits to the ground caused by low insulation resistance. This ensures the safety of devices on the AC side of the power plant and helps customers save the hardware costs of IMDs.

02 Grid Connection Safety Applications & Success Stories

| Grid Supporting Success Stories

As the stability of power grids gradually decreases, the SCR fed to each grid connection point also decreases continuously. Therefore, inverters must maintain good adaptability when facing weaker power grids. Huawei's inverters are design to fully adapt to weak power grid scenarios in terms of grid connection support and perform well in terms of fault ride-through, harmonic suppression, and oscillation damping. In a PV project in Heilongjiang, a 100 MW PV plant was constructed using third-party inverters in the first phase, and a 20 MW PV plant was constructed using Huawei's string inverters at the same grid connection point in the second phase. The SCR of the grid connection point decreased due to the expansion of the plant capacity. As a result, the strong power grid changed to a weak power grid. During an inter-phase short circuit, different from third-party inverters that failed to ride through in a weak power grid, Huawei's string inverters successfully rode through and ran stably thanks to better adaptability to a weak power grid.

| Grid-Forming Success Stories

Huawei's Smart PV+ESS Solution has made a new breakthrough in power grid stability technologies, shifting from grid following to grid forming. The Saudi Arabia Red Sea project is the best practice of this solution. The project is a key infrastructure construction project in the "Saudi Arabia 2030 Vision". It consists of a 400 MW PV system and 1.3 GWh ESS to form a power grid with a small number of backup genset units. The system has high requirements on PV+ESS grid forming and power grid stability. Huawei provided this solution and completed the delivery in July 2023.

As a power grid featuring PV+ESS synergy, the overall operation logic and power grid performance indicators need to be designed and simulated in detail. With its capabilities in design, simulation, and test platforms, Huawei has helped customers complete relevant work in the past two years, including PV+ESS grid forming, power grid SCR design, energy distribution logic design, and power grid control stability design, transient state design, primary and secondary voltage and frequency regulation, PV/BESS/SVG dynamic voltage regulation, power grid frequency and voltage control after load shedding, synchronous black start of 1000+ PCSs, multi-switch collaboration in the power grid, and synchronous and asynchronous design, which are verified in real-world environments and can achieve the goal of stable operation.



> Saudi Arabia Red Sea Project



Summary

Currently, the installed capacity of PV power ranks the second among all energy sources, following that of thermal power. Bubbles of high-proportion PV and wind power integration and "high-speed" development begin to burst. The contradictions and obstacles that restrict the industry development are intractable. PV power generation has disadvantages such as intermittent, fluctuation, and low control. A high proportion of PV power threatens the power supply safety of the power grid. Improving the power grid friendliness of PV power generation is a priority in the industry. In recent years, electrical and mechanical safety accidents have occurred frequently during PV power generation, hindering the sound development of the industry. It is urgent to improve the active safety capability of PV plants.

Over the past two decades, PV power generation has achieved grid parity thanks to technological advancements. In the future, we shall make full use of cutting-edge technologies, especially digital intelligence, to smoothen the industry development. In recent years, Huawei has taken the lead in innovating technologies for improving power grid friendliness and active safety capability of power plants. These technologies have proved effective with numerous success stories and won recognition from the industry.

In general, the foundation for ultra-large-scale development of the industry needs to be further consolidated, and some technologies need to be further improved. Industry collaboration is our next step. Based on the development requirements of new productivity, excellent top-level design for industry development and brilliant R&D and application of fundamental technologies are required to lay a solid foundation for high-quality industry progress.

References

- 1 Xin Bao'an, *New Power System and New Energy System*, 2023.
- 2 Huawei Technologies Co., Ltd., *Smart PV+ESS Generator White Paper*, 2023.
- 3 NEA Wind and PV Power Simulation and Detection Certification Technological Key Lab, China General Certification Center, and Huawei Technologies Co., Ltd., *PV Array and Inverter Electrical Safety Design: Smart String-Level Disconnect White Paper*, 2021.
- 4 China General Certification Center and Huawei Technologies Co., Ltd., *PV Plant Smart Safety Technology White Paper*, 2023.